

AMERICAN PNEUMATIC TOOL

OPTIONAL RETAINERS (FOR APT STRAIGHT-NOSE CHIPPING HAMMERS)

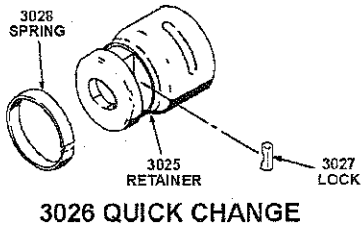

3026 QUICK CHANGE

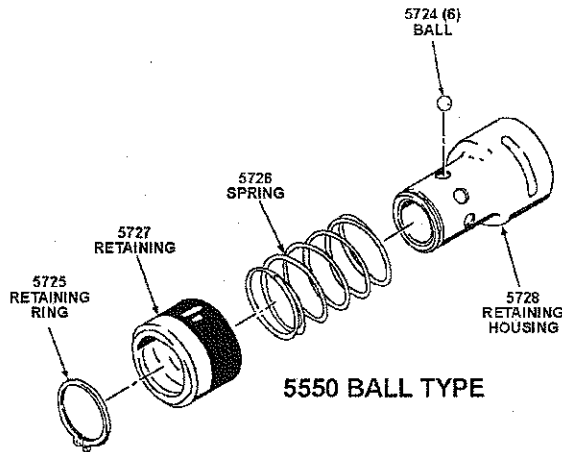

5550 BALL TYPE

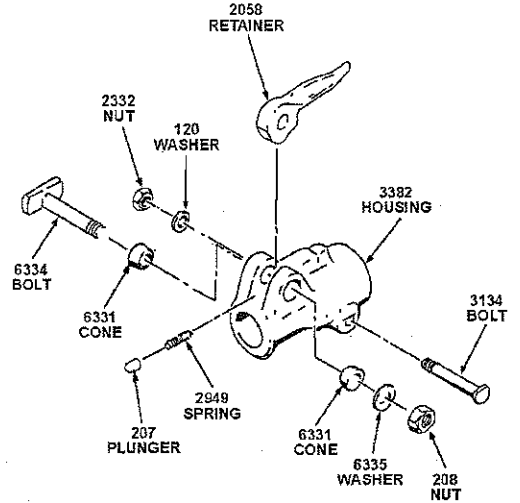

3383 LATCH-TYPE
IMPORTANT

DO NOT USE 3383 Latch-type Retainer with .580 hex-shank chipping hammer steel. The latch does not properly catch the round collar, thereby allowing the steel to shoot out of the chipping hammer. This retainer (3383 Assy) should only be used with .680 round collar or round shank steel only.



7022 OVAL COLLAR



6144 ROUND COLLAR

OPTIONAL RETAINER (FOR APT TAPERED-NOSE CHIPPING HAMMERS)



18210 OVAL COLLAR

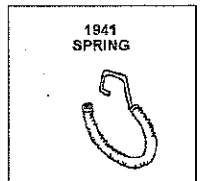

1941
SPRING

OPTIONAL FITTINGS

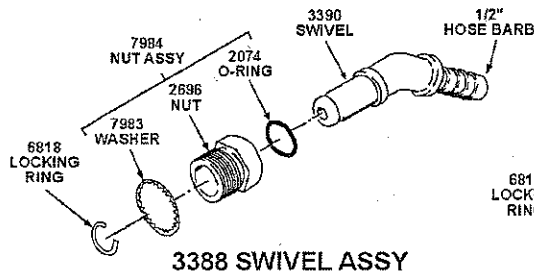

3388 SWIVEL ASSY

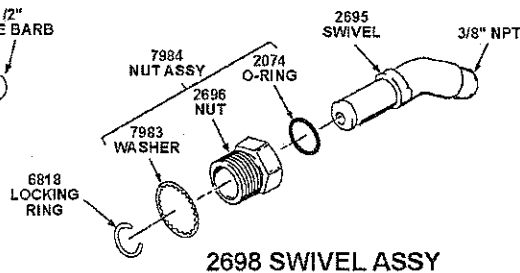

2698 SWIVEL ASSY

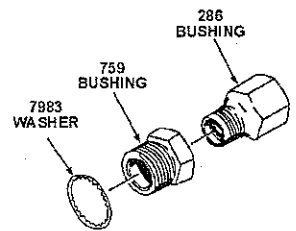

REDUCING BUSHING

CROWDER SUPPLY COMPANY 8495 ROSLYN ST, COMMERCE CITY, COLORADO 80022 TOLL FREE 888-883-5144 WWW.CROWDERSUPPLY.COM