

# CROWDER SUPPLY

888-883-5144

Rock Drilling and Construction Supplies

CROWDERSUPPLY.COM

- **MINING**
- **ROCK DRILLING**
- **CONSTRUCTION SUPPLIES**

Manufacturing & Distributing Since 1969 [www.CrowderSupply.com](http://www.CrowderSupply.com) • Toll Free: 888-883-5144



CROWDER  
SUPPLY

CROWDER  
PNEUMATICS

CROWDER  
HYDRAULIC  
TOOLS

CROWDER  
AIR  
TOOLS

AIR  
POST  
DRIVERS

Rhino

Air & Hydraulic Tools  
Air Hose & Accessories  
Cobra Combi Gas Powered Drills/Breakers  
Mining Supplies  
Split Set Drivers  
Bolt Drivers  
Tapered Drill Steel  
Tapered Rock Bits  
Integral Drill Rod  
Scaling Bars  
MAI & IBO Hollow Grout Rod  
Grout Swivels

Chipping Hammer Tools  
Paving Breaker Tools  
Pipe Drivers  
"H" & "D" Steel & Bits  
Whirlbits  
Betonamit—Expansive Cracking Agent  
1" ROPE - R25 - 100 ROPE  
1 ¼" ROPE - R32 - 125 ROPE  
1 ½" ROPE - R38 - 150 ROPE  
T38, T45, T51 Threaded Steel & Bits  
Striking Bars  
Shank Adapters

CrowderSupply.com

CrowderPneumatics.com

CrowderHydraulicTools.com

CrowderAirTools.com

AirPostDrivers.com

**CROWDER  
SUPPLY**



Paving Breaker Tools, Chipping Tools, Hammer Tools, & More!

**CROWDER  
PNEUMATICS**

Chicago Pneumatic Dealer



Pneumatic Tools Breakers, Drills, & More

**CROWDER  
HYDRAULIC  
TOOLS**



Atlas Copco  
Hydraulic Paving Breakers, Post Drivers, Drills, Hammers & Accessories

**CROWDER  
AIR  
TOOLS**



APT Pneumatic Breakers, Drills, Hammers & More

**AIR POST  
DRIVERS**



Rhino  
Pneumatic Post Drivers, Post Pullers

**Air & Hydraulic Tools**



**INGERSOLL RAND, THOR, CP, JOY, GARDNER DENVER, APT, ATLAS COPCO, and more**

**AIR TOOLS PARTS BREAKDOWNS**

Visit our web site, [CROWDERSUPPLY.COM](http://CROWDERSUPPLY.COM), for detailed parts breakdowns on tools from the manufacturer's below. You'll find part numbers, tool diagrams and user manuals for various models of tools.



We provide either Adobe Acrobat PDF files or pictures of breakdown sheets.

- ◆ American Pneumatic Tool (APT)
- ◆ Atlas Copco
- ◆ ATSCO
- ◆ Chicago Pneumatic (CP)
- ◆ Continental Power Tools
- ◆ Gardner-Denver
- ◆ Henry
- ◆ Hatco
- ◆ Ingersoll-Rand
- ◆ Jet
- ◆ Joy
- ◆ Kent
- ◆ Leroi-Schramm
- ◆ MacDonald
- ◆ Mid-Western
- ◆ Rhino
- ◆ SullAir
- ◆ Texas Pneumatic
- ◆ Thor
- ◆ Toyo
- ◆ Worthington

[www.CrowderSupply.com](http://www.CrowderSupply.com) • Toll Free: 888-883-5144

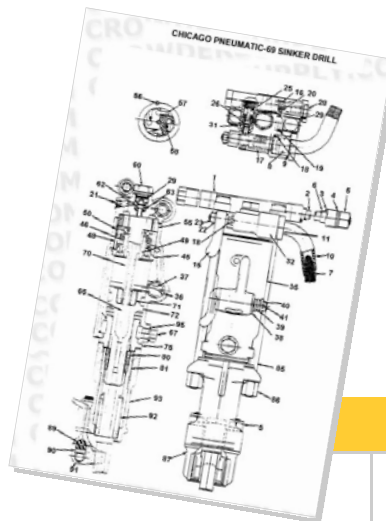

**WE SUPPLY A FULL RANGE OF PNEUMATIC AND HYDRAULIC TOOLS**

Visit our web sites for details and ordering information on Air and Hydraulic Tools:

- [CrowderAirTools.com](http://CrowderAirTools.com)
- [CrowderPneumatics.com](http://CrowderPneumatics.com)
- [CrowderHydraulicTools.com](http://CrowderHydraulicTools.com)
- [AirPostDrivers.com](http://AirPostDrivers.com)

- ◆ ROCK DRILLS
- ◆ JACK LEG DRILLS
- ◆ STOPPER DRILLS
- ◆ PLUG HOLE DRILLS
- ◆ PAVING BREAKERS
- ◆ CLAY DIGGERS
- ◆ TRENCH DIGGERS
- ◆ CHIPPING HAMMERS
- ◆ RIVET BUSTERS
- ◆ POGO TAMPERS
- ◆ POST DRIVERS



**Air King Universal Coupling**



Hose Ends



Male NPT Ends



Female NPT Ends

1/4"	AMH	\$9.80	AMB1	\$9.70	AMC1	\$8.65
3/8"	AM1	\$6.20	AMB	\$8.35	AMC	\$8.35
1/2"	AM5	\$9.15	AM2	\$7.25	AM3	\$7.65
3/4"	AM6	\$6.25	AM7	\$9.15	AM8	\$7.35
1"	AM11	\$8.20	AM12	\$8.25	AM13	\$9.30

**BOSS FITTINGS**



See our web site for:

- Boss Ground Joint Air Hammer Fittings
- Boss Ground Joint Fittings
- Boss Washer Seal Fittings

We also carry **Dixon** Hose Clamps

**Air Hose & Accessories**



ROCK DRILL OIL	
RDO55G	ROCK DRILL OIL 55 GALLON
RDO5G	ROCK DRILL OIL 5 GALLON
RDO1G	ROCK DRILL OIL 1 GALLON

THREAD LUBE						
	Jet Lube - J75		Jet Lube - J89 (pumpable)		KOPR-KOTE	
						
1 Gal	J751G	\$42.21	J891G	\$40.82	JK1G	\$55.41
2 Gal	J752G	\$76.52	J892G	\$74.31	JK2G	\$122.49
5 Gal	J755G	\$162.43	J895G	\$162.43	JK5G	\$209.47
MSDS	Data Sheets available on our web site: <a href="http://www.CrowderSupply.com">www.CrowderSupply.com</a> • Toll Free: 888-883-5144					

AIR HOSE	
AIR-H-19-50	CONTRACTORS AIR HOSE 3/4" X 50' W/FITTINGS
AIR-H-25-50	CONTRACTORS AIR HOSE 1" X 50' W/FITTINGS
AIR-H-25-WB	1" WIRE BRAID
AIR-H-32-WB	1 1/4" WIRE BRAID
AIR-H-50-WB	2" WIRE BRAID
AIR-H-12-WHP	WHIP HOSE 1/2" X 6' UNIVERSAL CPLG AND SWIVEL



Triple Connect  
AM10  
\$21.25



Blank End  
AM0  
\$11.90



Washer  
AWR4  
Each \$0.80  
Bag (50) \$35.00



**LINE OILER**

Aluminum - Pressure Feed



LO-5PF	1/6 Pint	1/2" NPT	\$45.00
LO-10PF	1/3 Pint	3/4" NPT	\$52.00
LO-15PF	1/2 Pint	3/4" NPT	\$58.00
LO-30PF	1 Pint	1" NPT	\$74.00

All Steel - Joy Football Style - Constant Feed



LO-JOY-FB	1 Pint	1-1/4" NPT	\$205.00
-----------	--------	------------	----------



LO-60-CF	1 Quart	1-1/4" or 1-1/2" NPT	\$341.25
LO-120-CF	2 Quart	1-1/4" or 1-1/2" NPT	\$348.60
LO-180-CF	3 Quart	1-1/4" or 1-1/2" NPT	\$551.25
LO-230-CF	1 Gallon	2" or 2 1/2" NPT	\$855.00
LO-290-CF	1.5 Gallon	2" or 2 1/2" NPT	\$1002.75
LO-690-CF	3 Gallon	2-1/2 or 3" NPT	\$1601.25



WHIP CHECK	
WCSML	WHIP CHECK 1/2" - 1 1/4" HOSE
WCLRG	WHIP CHECK 1 1/2" - 3" HOSE

**CROWDER SUPPLY**



**CROWDER PNEUMATICS**



**CROWDER HYDRAULIC TOOLS**



*Atlas Copco*

**CROWDER AIR TOOLS**



**AIR POST DRIVERS**





**GAS POWERED BREAKERS/DRILLS**

**Cobra Combi, Cobra mk1, Cobra TT**

**Freedom of Movement, Zero Setup Time!**

*Our Gas Powered Breakers/Drills:*

- ◆ Are Easy to Operate
- ◆ Run without a Compressor
- ◆ Hits harder than a 60 lb. air breaker
- ◆ Hits twice as hard as an electric breaker

With no compressors, hoses or cables to set up, gas breakers are ideal for smaller jobs. They are indispensable for tasks that involve moving along a line, from position to position. Or for working in remote, inaccessible locations. And for many years, they have been a standard piece of equipment for emergency teams.

But the Cobra Combi is not only a self-contained breaker, it's a powerful drill as well. It can sink holes to the depth of 6.5 feet, and drill up to 12 inches per minute in solid granite.

**A Multi-Purpose Tool**

With a range of 18 different tools, you can use the Cobra Combi for everything from cutting and breaking to drilling, driving and compacting. So whether you need to just break a small patch of concrete, or split a rock, you can get the job finished with a gas-powered machine in the same time it takes just to set up a compressor and hoses.

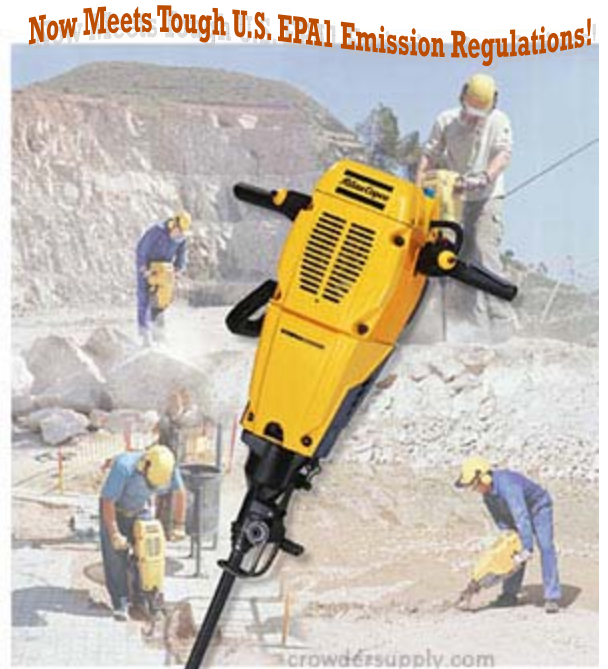

Breaking Concrete



Cutting Asphalt



Drilling



Digging



Splitting Rocks



**You can use the multi-purpose Cobra Combi to:**

- ◆ Break Concrete
- ◆ Cut Asphalt
- ◆ Drill
- ◆ Dig
- ◆ Split Rocks
- ◆ Drive Posts and Fences
- ◆ Drive Rods and Spikes
- ◆ Tamp and Compact Soil
- ◆ Tamp Ballast/Ties

## Cobra Combi

The Atlas-Copco Cobra Combi is a successor to the earlier and well-known model Cobra 149 and the Pionjar Gas Drills. At the same time it is unique in its design since several improvements have been made to meet both environmental requirements from authorities as well as operators demand of ergonomic design and user comfort.

### CLEANER EMISSIONS, LOWER VIBRATIONS, LESS NOISE

It is not only the design that is new on the Cobra Combi. Firstly, the noise level is lowered from 114 to 110 dB thanks to a new muffler and it is thereby fulfilling the European Noise Emission Directive (NED). Secondly, new vibration dampened handles reduces vibration levels from 8 to 5 m/s<sup>2</sup>. Also, with a new carburettor and a catalytic converter, the emissions are cleaner and meet the tough US emission regulations, EPA1. Further, with a new choke control, new carburettor and user-friendly start instructions, Cobra Combi is easy to use. The new gas control gives the operator better control of the speed and enhance the precision when operating.



### TECHNICAL SPECIFICATIONS

Weight	Length	Depth	Width over handles	Tool shank	Sound level (Acc. to ISO 3744)	Vibrations level (Acc. to ISO 8662)
55 lbs	28.81 in	11.06 in	23.03 in	7/8" - 4 1/4"	110 dB	5 m/s <sup>2</sup>

ENGINE  
www.CrowderSupply.com • Toll Free: 888-883-5144

Type	Power	Cooling system	Starter system	Recommended fuel	Oil type	Oil mix	Fuel capacity	Fuel consumption	Part number
185 cc 1-cylinder, 2-stroke	1kW	Forced air	Recoil starter	Unleaded	Atlas Copco two-stroke oil or similar	2% 1:50	0.31 US Gallon	0.36 US Gallon/hour	8318 0800 00

### Cobra Combi - Combination Breaker/Drill

Model	Part Number	Tool Size	Price
Cobra Combi	8318 0800 03	7/8" x 4-1/4" Chuck	\$4635

### CAPACITY

Impact rate	Drilling speed (In granite, 1 21/64 drill)	Max drilling depth
2600 BPM	11.8 in/min <sup>2</sup>	6.5 ft



**Cobra mk1 & Cobra TT**

**COBRA MK1**



The Cobra mk1 is the hardest hitting petrol driven breaker on the market. It incorporates a number of unique design features. The vibration-dampened handle frame serves as both a protection against rough handling and a fuel tank, keeping the fuel away from the heat of the engine. Thanks to the patented leaf-spring construction, vibrations are down to an unprecedented 2.3 m/s<sup>2</sup>. Approved according to EPA 1, the Cobra mk1 meets the toughest emission requirements in the world.

- ◆ Hard hitting, 60-joule performance.
- ◆ Ideal for a wide range of applications such as; breaking concrete, cutting asphalt, tamping ballast, digging and other tasks.
- ◆ Extremely low vibrations: only 2.3 m/s<sup>2</sup>.
- ◆ Easy maintenance and service.
- ◆ EPA 1 approved.



Model	Part Number	Tool Size	Price
Cobra mk1	8318 0700 07	1-1/8" x 6" Chuck	\$4,025
Cobra mk1	8318 0700 03	1-1/4" x 6" Chuck	\$4,025

www.CrowderSupply.com • Toll Free: 888-883-5144

**COBRA TT**



The Cobra TT is specially designed for tie tamping. Its portability and flexibility eliminate traffic disruptions caused from local ballast compunction. For maximum comfort, the Atlas Copco Hand and Arm Protection System (HAPS) achieves a very low vibration level. For optimal tie tamping and other maintenance jobs, the Cobra TT is right on track.

- ◆ Specially developed for tie tamping
- ◆ Impact energy of 40 Joule
- ◆ Unique vibration dampening
- ◆ Environmental friendly



Model	Part Number	Tool Size	Price
Cobra TT	8318 0700 11	1-1/4" x 6" Chuck	\$4,350
Cobra TT	8318 0700 15	1-1/8" x 6" Chuck	\$4,350



**MAI & IBO  
Hollow Grout Rod**

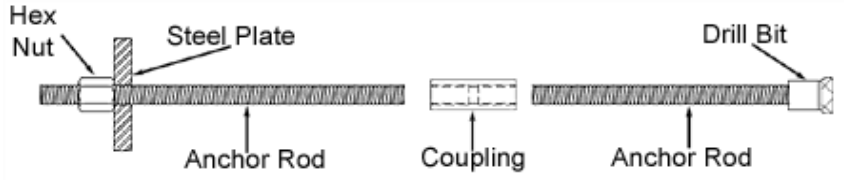

MAI BITS							
Hardened Steel Soil Bits				Carbide Rock Bits			
	R32	R38	R51	R32	R38	R51	T76
2	IBOR32-BS51	IBOR38-BS51		IBOR32-BC51			
2-1/2"	IBOR32-BS64	IBOR38-BS64		IBOR32-BC64	IBOR38-BC64		
3"	IBOR32-BS76	IBOR38-BS76	IBOR51-BS76	IBOR32-BC76	IBOR38-BC76	IBOR51-BC76	
3-1/2"	IBOR32-BS89	IBOR38-BS89	IBOR51-BS89	IBOR32-BC89	IBOR38-BC89	IBOR51-BC89	
4"	IBOR32-BS102	IBOR38-BS102	IBOR51-BS102	IBOR32-BC102	IBOR38-BC102	IBOR51-BC102	IBOT76-BC102
5"	*non stock-made to order Titan 30 & 40 bit also available			IBOR32-BC127	IBOR38-BC127	IBO51-BC127	IBOT76-BC127



Anchor	Outside Diameter	Internal Diameter (Avg)	Effective Cross Sectional Area (Avg)	Ultimate Load Capacity	Yield Load Capacity	Weight per Foot
R 25	1"	0.55"	0.38 in <sup>2</sup>	45 kips	33.8 kips	1.5 lbs
R 32N	1-1/4"	0.73"	0.61 in <sup>2</sup>	63 kips	51.5 kips	2.3 lbs
R 32S	1-1/4"	0.59"	0.76 in <sup>2</sup>	81 kips	63 kips	2.85 lbs
R 38	1-3/4"	0.91"	1.04 in <sup>2</sup>	90 kips	90 kips	4.0 lbs
R 51L	2"	1.42"	1.20 in <sup>2</sup>	123.6 kips	101.2 kips	4.7 lbs
R 51N	2"	1.30"	1.46 in <sup>2</sup>	180 kips	141.6 kips	5.6 lbs
T 76N	3"	2"	2.84 in <sup>2</sup>	360 kips	270 kips	10.0 lbs
T 76S	3"	1.77"	3.72 in <sup>2</sup>	428 kips	338 kips	13.2 lbs

www.CrowderSupply.com • Toll Free: 888-883-5144

See our web site, crowdersupply.com for PDF spec sheets

**GROUT SWIVELS**

	GROUT SWIVEL	FLUSHING COLLAR	JUNCTION BAR	SEALS
R32 - 1 1/4" ROPE	GSR32	GSR32-FC	GSR32-JB	GSR32-S
R38 - 1 1/2" ROPE	GSR38	GSR38-FC	GSR38-JB	GSR38-S
T38	GST38	GST38-FC	GST38-JB	GST38-S



**COUPLING ADAPTERS**

Part Number	Description	Part Number	Description
CPLR32S	COUPLING 1-1/4" ROPE, SQUARE	CPLR38SQ	COUPLING 1-1/2" ROPE, SQUARE
CAR32-R38	1-1/4" ROPE - 1-1/2" ROPE	CAR38-T38	1-1/2" ROPE - T38
CAR32-R38SQ	1-1/4" ROPE - 1-1/2" ROPE, SQUARE	CAR38-T45	1-1/2" ROPE - T45
CAR32-T38	1-1/4" ROPE - T 38	CAR38-T51	1-1/2" ROPE - T51
CAR32-T38	1-1/4" ROPE - T38, SQUARE	CAR38-R51	1-1/2" ROPE - 2" ROPE
CAR32-T45	1-1/4" ROPE - T45	CAT38-T45	T38 - T45
CAR32-T51	1-1/4" ROPE - T51	CAT45-T51	T45 - T51
CAR32-R51	1-1/4" ROPE - 2" ROPE	CAT45-R51	T45 - 2" ROPE
		CAT45-T76	T45 - T76
		CAT51-R51	T51 - 2" ROPE
		CAT51-T76	T51 - T76

**RESIN COVERAGE TABLE**

HOLE DIAMETER	HOLE DIAMETER													
	1	1-1/8	1-1/4	1-3/8	1-1/2	1-5/8	1-1/2	1-5/8	1-3/4	1-7/8	2	2-1/4	2	2-1/4
INCH	1	1-1/8	1-1/4	1-3/8	1-1/2	1-5/8	1-1/2	1-5/8	1-3/4	1-7/8	2	2-1/4	2	2-1/4
MM	26	29	32	36	38	42	38	42	45	48	51	58	51	58
CARTRIDGE DIAMETER	CARTRIDGE DIAMETER													
	INCH	7/8	1	1-1/8	1-1/4	1-1/4	1-1/4	1-3/8	1-3/8	1-9/16	1-9/16	1-9/16	1-9/16	1-3/4
MM	23	26	28	32	32	36	36	36	40	40	40	40	45	45
Bolt Size	COVERAGE MULTIPLIER													
	3/4"	1.75	1.43											
7/8"		2.01	1.59	1.39			1.27							
1"			2.25	1.75	1.25		1.52	1.16	1.19					
1-1/8"					1.60	1.14	1.94	1.38	1.37					
1-1/4"						1.53		.85	1.69	1.3			1.28	
1-3/8"									2.27	.61	1.21		1.52	1



**SPLIT SET DRIVERS**

**1-PIECE DRIVER**

SSD1PC	7/8 X 4-1/4 - 13"OAL
SSD1PC-B	7/8 X 4-1/4 - 13"OAL BULB NOSE
SSD1PC33	7/8 X 4-1/4 - 13"OAL 33MM NOSE
SSD1PC-88	1 X 4-1/4 - 13"OAL
SSD1PC-18	7/8 X 4-1/4 - 18"OAL
SSD1PC-24	7/8 X 4-1/4 - 24"OAL
SSD1PC-30	7/8 X 4-1/4 - 30"OAL
SSD1PC-30B	7/8 X 4-1/4 - 30"OAL BULB NOSE
SSD1PC-36	7/8 X 4-1/4 - 36"OAL



**WE CAN BUILD IT**

Don't see what you need?  
Call us at **888-883-5144**



**SPLIT SET DRIVER HEAD - TAPERED SOCKET**

SSD7811	7/8 X 11° TAPER
SSD781133	7/8 X 11° TAPER, 33MM NOSE
SSD7812	7/8 X 12° TAPER
SSD781233	7/8 X 12° TAPER, 33MM NOSE
SSD8811	1 X 11° TAPER
SSD8812	1 X 12° TAPER



www.CrowderSupply.com • Toll Free: 888-883-5144

**SPLIT SET DRIVER HEAD - THREADED**

SSDR25F-B	R25 FEMALE BULB NOSE
SSDR25S-F	R25 FEMALE, STANDARD NOSE
SSDR2533	R25 FEMALE, 33MM NOSE
SSDR32F-B	R32 FEMALE, BULB NOSE
SSDR32F-S	R32 FEMALE, STANDARD NOSE
SSDR3233	R32 FEMALE, 33MM NOSE
SSDR32F-10.7	R32 FEMALE 12¼" OAL, 1½" NOSE
SSDR32F-24	R32 FEMALE 24"OAL
SSDR32F-30	R32 FEMALE 30"OAL
SSDR32M-18	R32 MALE 18"OAL 4"STD NOSE
SSDR32F-S46	R32 FEMALE 46MM NOSE



SSDR38M	R38 MALE 8 ¼" OAL, 2 ¾" NOSE
SSDR38F-10.7	R38 FEMALE, 10 ¾"OAL, 1 ¾" NOSE
SSDR38F-11.7	R38 FEMALE, 11 ¾"OAL 1 ¾" NOSE
SSDR38F-13.7	R38 FEMALE, 13 ¾"OAL 1 ¾" NOSE
SSDR38F-15.7	R38 FEMALE, 15 ¾"OAL 1 ¾" NOSE
SSDR32F-20	R38 FEMALE, 20"OAL, 2 ¾" NOSE
SSDT38	T38 FEMALE
SSDT38F-12.5	T38MALE 12½"OAL - 1½" NOSE



**1 x 6 1/4 SHANK DRIVERS**

SSD89-15	1 X 6¼" - 15"OAL, 2¼" NOSE
SSD89-15.75	1 X 6 ¼" - 15 ¾"OAL, 2 ½" NOSE
SSD89-18	1 X 6 ¼" - 18"OAL, 2 ¾" NOSE
SSD89-18S	1 X 6 ¼" - 18"OAL, 4" STANDARD NOSE
SSD89-20	1 X 6¼" - 20"OAL, 2¾" NOSE
SSD89-21.25	1 X 6 ¼" - 21 ¼"OAL, 2 ¾" NOSE
SSD89-21.5	1 X 6¼" - 21½"OAL, 2¼" NOSE
SSD89-22	1 X 6 ¼" - 22"OAL, 1 ½" NOSE (6.25-I)
SSD89-24	1 X 6¼" - 24"OAL, 4" BULB NOSE
SSD89-30	1 X 6 ¼" - 30 " AOL, 4" STANDARD NOSE
SSD89-32	1 X 6 ¼" - 32" AOL, 4" STANDARD NOSE
SSD89-40MC	1 X 6 ¼" - 40" AOL, 4" BULLET NOSE
SSD89-42MC	1 X 6 ¼" - 42" AOL, 4" BULLET NOSE



**Split Set Bolts**

**SPECIAL**

SSDT13	TAMROCK, SECOMA 
SSD-JH4-20	JH4, 503MM LONG 



Bolt spinners also available for Williams or Titan Rod

WE BUILD DRIVERS TO YOUR SPECIFICATIONS

**Bolt Drivers - Resin**



**DYWIDAG OVAL SOCKET SPINNER**

	7/8 X 3 1/4	1 x 3 1/4	R25	R32	R38	T38	T45
#6	DDY77-6-10	DDY87-6-10	DDYR25-6	DDYR25-6	DDYR38-6	DDYT38-6	DDYT45-6
#7	DDY77-7-10	DDY87-7-10	DDYR25-7	DDYR32-7	DDYR38-7	DDYT38-7	DDYT45-7
#8	DDY77-8-10	DDY87-8-10	DDYR25-8	DDYR32-8	DDYR38-8	DDYT38-8	DDYT45-8
#8 G150	DDY77-8HS-10	DDY87-8HS-10	DDYR25-8HS	DDYR32-8HS	DDYR38-8HS	DDYT38-8HS	DDYT45-8HS
#9	DDY77-9-10	DDY87-9-10	DDYR25-9	DDYR32-9	DDYR38-9	DDYT38-9	DDYT45-9
#10	DDY77-10-10	DDY87-10-10	DDYR25-10	DDYR32-10	DDYR38-10	DDYT38-10	DDYT45-10
#11	DDY77-11-10	DDY87-11-10	DDYR25-11	DDYR32-11	DDYR38-11	DDYT38-11	DDYT45-11
1 1/4" G150	DDY77-11HS-10	DDY87-11HS-10	DDYR25-11HS	DDYR32-11HS	DDYR38-11HS	DDYT38-11HS	DDYT45-11HS

**NUT SPINNER**

Nut spinners are normally made to order. We need to know:

1. What is the drive end? Shank, Threaded, Square Impact Drive
2. What Size Nut you are Tightening?
3. How far down the bolt do you want to spin the nut, or the over-all driver length?

Here are some samples of some common nut spinner we build:

TT77-7-22	7/8 x 3-1/4" x 22" OAL, 1-1/8" SQ
TT77-7-30	7/8 x 3-1/4" x 30" OAL, 1-1/8" SQ
TT77-7-36	7/8 x 3-1/4" x 36" OAL, 1-1/8" SQ
TT77-7-48	7/8 x 3-1/4" x 48" OAL, 1-1/8" SQ
TT77-1625-22	7/8 x 3-1/4" x 22" OAL, 1-5/8" HEX
TT89-7-25	1 X 6-1/4" X 25" OAL, 1-1/8" SQ
TTR32F-7-16	DRIVER R32F X 16" OAL, 1-1/8" SQ
TTR32F-8-21	DRIVER R32M X 21" OAL, 1-5/8" HEX
TTR38F-8-13	DRIVER R38F x 13" OAL, 1-5/8" HEX



- Also available in 4-1/4" shank length
- For threaded rather than oval socket add "T" to end of part #
- For 7/8 x 4-1/4 shank use part# prefix DDY78
- For 1 x 4-1/4 shank use part# prefix DDY88

**7/8" FEMALE DOLLY**

7/8 Hex Socket to Press on Tapered Steel

DDY78HF-7	7/8 HEX FEMALE X #7 OVAL SOCKET
DDY78HF-8	7/8 HEX FEMALE X #8 OVAL SOCKET



**ROOF BOLT DRIVER  
1 1/8" SQUARE SOCKET**

RBD77-10	ROOF BOLT DR 7/8 X 3 1/4 X 10" OAL
RBD77-27	ROOF BOLT DR 7/8 X 3 1/4 X 27" OAL
RBD77-48	ROOF BOLT DR 7/8 X 3 1/4 X 48" OAL
RBD78HF	7/8HEX FEMALE X 1 1/8" SOCKET



**SPLIT SETS**

**SPLIT BOLTS**

	33MM	39MM	46MM
See Specs on our Web Site	<b>Model SS-33</b> 1.3" (33mm) Dia.	<b>Model SS-39</b> 1.5" (39mm) Dia.	<b>Model SS-46</b> 1.8" (46mm) Dia.
18"	SS33-18	SS39-18	SS46-18
2'	SS33-24	SS39-24	SS46-24
3'	SS33-36	SS39-36	SS46-36
4'	SS33-48	SS39-48	SS46-48
5'	SS33-60	SS39-60	SS46-60
6'	SS33-72	SS39-72	SS46-72
8'	SS33-96	SS39-96	SS46-96
10'	SS33-120	SS39-120	SS46-120
12'	SS33-144	SS39-144	SS46-144
PLATES	SS-PLATE33	SS-PLATE39	SS-PLATE46

SPLIT BOLTS AVAILABLE GALVANIZED  
OTHER LENGTHS AVAILABLE

CROWDER SUPPLY



CROWDER PNEUMATICS



CROWDER HYDRAULIC TOOLS



CROWDER AIR TOOLS



AIR POST DRIVERS



**Tapered Drill Steel & Bits**

	7/8 x 11° TAPERED		1 x 11°	7/8 x 12° TAPERED STEEL	
	7/8 X 3/4	7/8 X 4/4	1 X 4/4	7/8 X 3/4	7/8 X 4/4
1'	DS7711-12	DS7811-12	DS8811-12	DS7712-12	DS7812-12
1'6	DS7711-18	DS7811-18	DS8811-18	DS7712-18	DS7812-18
2'	DS7711-24	DS7811-24	DS8811-24	DS7712-24	DS7812-24
2'6	DS7711-30	DS7811-30	DS8811-30	DS7712-30	DS7812-30
3'	DS7711-36	DS7811-36	DS8811-36	DS7712-36	DS7812-36
3'6	DS7711-42	DS7811-42	DS8811-42	DS7712-42	DS7812-42
4'	DS7711-48	DS7811-48	DS8811-48	DS7712-48	DS7812-48
4'6	DS7711-54	DS7811-54	DS8811-54	DS7712-54	DS7812-54
5'	DS7711-60	DS7811-60	DS8811-60	DS7712-60	DS7812-60
5'6	DS7711-66	DS7811-66	DS8811-66	DS7712-66	DS7812-66
6'	DS7711-72	DS7811-72	DS8811-72	DS7712-72	DS7812-72
6'6	DS7711-78	DS7811-78	DS8811-78	DS7712-78	DS7812-78
7'	DS7711-84	DS7811-84	DS8811-84	DS7712-84	DS7812-84
7'6	DS7711-90	DS7811-90	DS8811-90	DS7712-90	DS7812-90
8'	DS7711-96	DS7811-96	DS8811-96	DS7712-96	DS7812-96
8'6	DS7711-102	DS7811-102	DS8811-102	DS7712-102	DS7812-102
9'	DS7711-108	DS7811-108	DS8811-108	DS7712-108	DS7812-108
10'	DS7711-120	DS7811-120	DS8811-120	DS7712-120	DS7812-120
10'6	DS7711-126	DS7811-126	DS8811-126	DS7712-126	DS7812-126
11'	DS7711-132	DS7811-132	DS8811-132	DS7712-132	DS7812-132
12'	DS7711-144	DS7811-144	DS8811-144	DS7712-144	DS7812-144
13'	DS7711-156	DS7811-156		DS7712-156	DS7812-156
14'	DS7711-168	DS7811-168		DS7712-168	DS7812-168
15'	DS7711-180	DS7811-180		DS7712-180	DS7812-180
21'	DS7711-252	DS7811-252		DS7712-252	DS7812-252



**7/8" x 11° SINGLE PASS**

TB71125	TAPERED BIT 7/8 X 11° 1"
TB71128	TAPERED BIT 7/8 X 11° 1 1/8"
TB71132	TAPERED BIT 7/8 X 11° 1 1/4"
TB71135	TAPERED BIT 7/8 X 11° 1 3/8"
TB71138	TAPERED BIT 7/8 X 11° 1 1/2"
TB71141	TAPERED BIT 7/8 X 11° 1 5/8"
TB71145	TAPERED BIT 7/8 X 11° 1 3/4"
TB71148	TAPERED BIT 7/8 X 11° 1 7/8"
TB71151	TAPERED BIT 7/8 X 11° 2"

**7/8" x 11° DEEP INSERT**

TB71135D	TAPERED BIT 7/8 X 11° 1 3/8"
TB71138D	TAPERED BIT 7/8 X 11° 1 1/2"
TB71141D	TAPERED BIT 7/8 X 11° 1 5/8"

**1" x 11° SINGLE PASS**

TB81135	TAPERED BIT 1" X 11° 1 3/8"
TB81138	TAPERED BIT 1" X 11° 1 1/2"
TB81141	TAPERED BIT 1" X 11° 1 5/8"
TB81145	TAPERED BIT 1" X 11° 1 3/4"
TB81151	TAPERED BIT 1" X 11° 2"

**7/8" x 12° DEEP INSERT**

TB71225	TAPERED BIT 7/8 X 12° 1"
TB71235	TAPERED BIT 7/8 X 12° 1 3/8"
TB71238	TAPERED BIT 7/8 X 12° 1 1/2"
TB71241	TAPERED BIT 7/8 X 12° 1 5/8"
TB71245	TAPERED BIT 7/8 X 12° 1 3/4"
TB71251	TAPERED BIT 7/8 X 12° 2"

**NEED REPAIR?**  
We can retaper, unplug and straighten your steel.

**NEED SPECIAL LENGTH?**  
We can cut and taper steel to any length.



**REAMING BITS**

BR22MM67	REAMING BIT BUTTON 2 1/2"
BR22MM76	REAMING BIT BUTTON 3"
BR22MM89	REAMING BIT BUTTON 3 1/2"
BR22MM57C	REAMING BIT 6-WING 2 1/4"
BR22MM64C	REAMING BIT 6-WING 2 1/2"
BR22MM76C	REAMING BIT 6-WING 3"

**BIT SHELLS**

BR-BS7811-6	REAMING BIT ADAPT 7/8" X 11°
BR-BS7811-6	REAMING BIT ADAPT 7/8" X 12°
BR-BS8811-6	REAMING BIT ADAPT 1" X 11°



**TAPER GAUGE**

TG711	TAPER GAUGE 7/8" X 11°
TG811	TAPER GAUGE 1" X 11°
TG712	TAPER GAUGE 7/8" X 12°
TG812	TAPER GAUGE 1" X 12°

**BIT ADAPTER**

BAR25-7811	1" ROPE TO 7/8 X 11°
BAR22-7811	7/8" ROPE TO 7/8 X 11°
BAR25-7812	1" ROPE TO 1 X 12°

**BIT SHIMS**

SHIM1	BRASS SHIMS 7/8" X 11° OR 12°	.25
SHIM2	BRASS SHIMS 1" X 11° OR 12°	.25

**BIT KNOCKER**

BN78	BIT KNOCKER 7/8"
BN88	BIT KNOCKER 1"



**Integral Drill Rod**

**Reaming Equipment**



**7/8" X 4 1/4" X SERIES 16**

T78S16-24	7/8" X 4 1/4" X 2'0" X 1-3/8" BIT
T78S16-47	7/8" X 4 1/4" X 3'11" X 1-11/32" BIT
T78S16-71	7/8" X 4 1/4" X 5'11" X 1-19/64" BIT
T78S16-94	7/8" X 4 1/4" X 7'10" X 1-1/4" BIT

**7/8" X 4 1/4" X SERIES 17**

T78S17-24	7/8" X 4 1/4" X 2'0" X 1-5/8" BIT
T78S17-47	7/8" X 4 1/4" X 3'11" X 1-37/64" BIT
T78S17-71	7/8" X 4 1/4" X 5'11" X 1-17/32" BIT
T78S17-78	7/8" X 4 1/4" X 6'6" X 1-17/32" BIT
T78S17-94	7/8" X 4 1/4" X 7'10" X 1-1/2" BIT

**7/8" X 4 1/4" X SERIES 11**

T78S11-31	7/8" X 4 1/4" X 2'7" X 1-11/32" BIT
T78S11-63	7/8" X 4 1/4" X 5'3" X 1-19/64" BIT
T78S11-94	7/8" X 4 1/4" X 7'10" X 1-1/4" BIT
T78S11-126	7/8" X 4 1/4" X 10'6" X 1-7/32" BIT
T78S11-156	7/8" X 4 1/4" X 13'1" X 1-3/16" BIT
T78S11-189	7/8" X 4 1/4" X 15'9" X 1-9/64" BIT
T78S11-220	7/8" X 4 1/4" X 18'4" X 1-7/64" BIT
T78S11-252	7/8" X 4 1/4" X 21' X 1-9/16" BIT

**7/8" X 4 1/4" X SERIES 12**

T78S12-31	7/8" X 4 1/4" X 2'7" X 1-37/64" BIT
T78S12-63	7/8" X 4 1/4" X 5'3" X 1-17/32" BIT
T78S12-94	7/8" X 4 1/4" X 7'10" X 1-1/2" BIT
T78S12-126	7/8" X 4 1/4" X 10'6" X 1-23/64" BIT
T78S12-156	7/8" X 4 1/4" X 13'1" X 1-27/36" BIT

**1" INTEGRAL DRILL RODS**

1" X 4 1/4"	
T88-24	1 x 4 1/4" x 2' X 1 3/4" BIT
T88-48	1 x 4 1/4" x 4' X 1 22/32" BIT
T88-72	1 x 4 1/4" x 6' X 1 11/18" BIT
T88-96	1 x 4 1/4" x 8' X 1 21/32" BIT

**THREADED PILOT ADAPTERS**

	6° (SMALL)	12° (LARGE)
1" ROPE (R25)	BR-PAR25-6	BR-PAR25-12
1 1/4" ROPE (R32)	BR-PAR32-6	BR-PAR32-12

**6° AND 12° REAMING BUTTON BITS**

	6° (SMALL)	12° (LARGE)
2 1/4"	BR6DG57	BR12DG57
2 1/2"	BR6DG64	BR12DG64
3"	BR6DG76	BR12DG70
3 1/2"	BR6DG89	BR12DG76
4"	BR6DG102	BR12DG89
		BR12DG102

**PILOT ROD  
7/8" X 4 1/4" 12° Carbide Insert**

PR78-31	PILOT ROD 7/8 X 4 1/4 - 12° CARBIDE INSERT 2'7"
PR78-47	PILOT ROD 7/8 X 4 1/4 - 12° CARBIDE INSERT 3,11"
PR78-63	PILOT ROD 7/8 X 4 1/4 - 12° CARBIDE INSERT 5'3"
PR78-79	PILOT ROD 7/8 X 4 1/4 - 12° CARBIDE INSERT 6'7"
PR78-94	PILOT ROD 7/8 X 4 1/4 - 12° CARBIDE INSERT 7'10"

**TAPERED BIT SHELLS**

BR-BS7811-6	REAMING BIT ADAPT 7/8" X 11°
BR-BS7811-6	REAMING BIT ADAPT 7/8" X 12°
BR-BS8811-6	REAMING BIT ADAPT 1" X 11°

**REAMING BITS**

	BUTTON BIT	6 - WING
2 1/4"	BR22MM57	BR22MM57C
2 1/2"	BR22MM67	BR22MM67C
2 3/4"	BR22MM70	BR22MM70C
3"	BR22MM76	BR22MM76C
3 1/2"	BR22MM89	BR22MM89C

www.CrowderSupply.com • Toll Free 888-883-5144





**“H” & “D” STEEL and BITS**

**H THREAD STEEL**  
(Shank Size)

Length	3/4 X 4 1/4	PRICE	7/8 X 3 3/4	PRICE	7/8 X 4 1/4	PRICE	1 X 4 1/4	PRICE
1'	DS68H-12	\$85.00	DS77H-12	\$56.60	DS78H-12	\$56.60	DS88H-12	\$61.00
1-1/2'	DS68H-18	\$93.00	DS77H-18	\$62.10	DS78H-18	\$62.10	DS88H-18	\$66.70
2'	DS68H-24	\$105.00	DS77H-24	\$67.20	DS78H-24	\$67.20	DS88H-24	\$73.40
2-1/2'			DS77H-30	\$72.60	DS78H-30	\$72.60	DS88H-30	\$79.80
3'			DS77H-36	\$78.90	DS78H-36	\$78.90	DS88H-36	\$86.20
4'			DS77H-48	\$89.30	DS78H-48	\$89.30	DS88H-48	\$98.20
5'			DS77H-60	\$103.60	DS78H-60	\$103.60	DS88H-60	\$111.40
6'			DS77H-72	\$111.30	DS78H-72	\$111.30	DS88H-72	\$123.90
8'			DS77H-96	\$132.60	DS78H-96	\$132.60	DS88H-96	\$148.80
10'			DS77H-120	\$155.10	DS78H-120	\$155.10	DS88H-120	\$173.80
12'			DS77H-144	\$176.90	DS78H-144	\$176.90	DS88H-144	\$198.90



Thread	Dimensions			PITCH PER INCH
	A	B	C	
H	.998	1-3/8"	.711	6
D	1.180	1-3/4"	.868	5
E	.623	7/8"	.711	6

**D THREAD STEEL**  
(Shank Size)

Length	3/4 X 4 1/4	PRICE	7/8 X 3 3/4	PRICE	7/8 X 4 1/4	PRICE	1 X 4 1/4	PRICE
1'	DS68D-12	\$83.90	DS77D-12	\$83.80	DS78D-12	\$83.80	DS88D-12	\$83.80
1-1/2'	DS68D-18	\$89.70	SA77D-18	\$89.70	DS78D-18	\$89.70	DS88D-18	\$89.70
2'	DS68D-24	\$110.00	DS77D-24	\$110.00	DS78D-24	\$110.00	DS88D-24	\$96.20
2-1/2'								
3'								
4'								
5'								
6'								



www.CrowderSupply.com • Toll Free: 888-883-5144

**ACCESSORIES - BIT ADAPTERS**

BAH-D	H THD (FM) - D THD (MALE)	\$35.80	DS88D-30	\$108.40
CPLH	H THD COUPLING	\$20.30	DS88D-36	\$110.40
BAR25-H	1" ROPE (FM) - H THD (MALE)	Call	DS88D-48	\$122.50
BAR25-D	1" ROPE (FM) - D THE (MALE)	Call	DS88D-60	\$137.40
			DS88D-72	\$149.90

We Carry Pneumatic & Hydraulic Rock Drills!  
Check Our Web Sites:

- CrowderAirTools.com (APT tools)
- CrowderPneumatics.com (CP tools)
- CrowderHydraulicTools.com (Atlas Copco)



**CARBIDE CROSS BIT**







Bit Diam.	H-THREAD		D-THREAD		H-THREAD	
	H-THREAD	PRICE	D-THREAD	PRICE	H-THREAD	PRICE
1-3/8"	BCH35	\$38.10	BDH35		BBH35	\$49.60
1-1/2"	BCH38	\$40.30	BDH38		BBH38	\$51.30
1-5/8"	BCH41	\$48.50	BDH41		BBH41	\$53.00
1-3/4"	BCH45	\$52.80	BDH45		BBH45	\$56.75
1-7/8"	BCH48	\$58.40	BDH48		BBH48	\$60.00
2"	BCH51	\$63.20	BDH51	\$65.00	BBH51	\$66.00
2-1/4"	BCH57	\$71.00	BDH57	\$73.00	BBH57	\$75.00
2-3/8"	BCH60	\$105.00	BDH60	Call		
2-1/2"	BCH64	\$96.00	BDH64	\$105.00	BBH64	\$105.00
2-5/8"	BCH67	\$115.00	BDH67	Call		
2-3/4"	BCH70	\$110.00	BDH70	Call		
3"	BCH76	\$129.90	BDH76	\$136.30		

**BUTTON BIT**

**ALL STEEL BITS**

Bit Diam.	H THREAD		D THREAD		CARBIDE SALLOW INSERT	
	H THREAD	PRICE	D THREAD	PRICE	H THREAD	PRICE
1-3/8"	BSH35	\$5.80			BCH35S	\$27.80
1-1/2"	BSH38	\$5.80			BCH38S	\$30.30
1-5/8"	BSH41	\$6.10			BCH41S	\$32.70
1-3/4"	BSH45	\$6.10	BSD45	\$7.90	BCH45S	\$35.40
1-7/8"	BSH48	\$6.40	BSD48	\$7.90		
2"	BSH51	\$6.40	BSD51	\$8.00	BCH51S	\$41.00
2-1/4"	BSH57	\$7.00	BSD57	\$8.30		
2-1/2"	BSH64	\$8.30	BSD64	\$8.60		
2-5/8"	BSH67	\$9.60				
2-3/4"			BSD70	\$8.80		
3"			BSD76	\$9.50		
3-1/4"			BSD83	\$10.60		
3-1/2"			BSD92	\$12.50		
4"			BSD101	\$25.60		

**Chipping Hammer Tools**

		 ROUND SHANK Oval Collar	 ROUND SHANK Round Collar	 HEX SHANK Oval Collar	 HEX SHANK Round Collar	PRICE
BLANK	8 1/2"	CH680-BLK-8	CH680R-BLK-8	CH580-BLK-8	CH580R-BLK-8	\$11.20
	11 1/2"	CH680-BLK-11	CH680R-BLK-11	CH580-BLK-11	CH580R-BLK-11	\$13.10
MOIL POINT	9"	CH680-MP-9	CH680R-MP-9	CH580-MP-9	CH580R-MP-9	\$12.90
	12"	CH680-MP-11	CH680R-MP-11	CH580-MP-11	CH580R-MP-11	\$15.30
	18"	CH680-MP-18	CH680R-MP-18	CH580-MP-18	CH580R-MP-18	\$19.60
	24"	CH680-MP-24	CH680R-MP-24	CH580-MP-24	CH580R-MP-24	\$24.90
	36"	CH680-MP-36	CH680R-MP-36	CH580-MP-36	CH580R-MP-36	\$32.80
	48"	CH680-MP-48	CH680R-MP-48	CH580-MP-48	CH580R-MP-48	\$43.30
	60"	CH680-MP-60	CH680R-MP-60	CH580-MP-60	CH580R-MP-60	\$53.40
	72"	CH680-MP-72	CH680R-MP-72	CH580-MP-72	CH580R-MP-72	\$62.40
NARROW CHISEL 	9"	CH680-NC-9	CH680R-NC-9	CH580-NC-9	CH580R-NC-9	\$12.90
	12"	CH680-NC-12	CH680R-NC-12	CH580-NC-12	CH580R-NC-12	\$15.30
	18"	CH680-NC-18	CH680R-NC-18	CH580-NC-18	CH580R-NC-18	\$19.60
	24"	CH680-NC-24	CH680R-NC-24	CH580-NC-24	CH580R-NC-24	\$24.90
	36"	CH680-NC-36	CH680R-NC-36	CH580-NC-36	CH580R-NC-36	\$32.80
	48"	CH680-NC-48	CH680R-NC-48	CH580-NC-48	CH580R-NC-48	\$43.30
	60"	CH680-NC-60	CH680R-NC-60	CH580-NC-60	CH580R-NC-60	\$53.40
	72"	CH680-NC-72	CH680R-NC-72	CH580-NC-72	CH580R-NC-72	\$62.40
1 1/2" CHISEL 	9"	CH680-C38-9	CH680R-C38-9	CH680-C38-9	CH680R-C38-9	\$15.30
	12"	CH680-C380-12	CH680R-C380-12	CH580-C380-12	CH580R-C380-12	\$17.80
	18"	CH680-C38-18	CH680R-C38-18	CH580-C38-18	CH580R-C38-18	\$22.60
2" CHISEL	9"	CH680-C51-9	CH680R-C51-9	CH580-C51-9	CH580R-C51-9	\$17.20
	12"	CH680-C51-12	CH680R-C51-12	CH580-C51-12	CH580R-C51-12	\$19.80
	18"	CH680-C51-18	CH680R-C51-18	CH580-C51-18	CH580R-C51-18	\$23.70
2 1/2" CHISEL	9"	CH680-C64-9	CH680R-C64-9	CH580-C64-9	CH580R-C64-9	\$35.50
	12"	CH680-C64-12	CH680R-C64-12	CH580-C64-12	CH580R-C64-12	\$37.80
	18"	CH680-C64-18	CH680R-C64-18	CH580-C64-18	CH580R-C64-18	\$42.70
3" CHISEL	9"	CH680-C76-9	CH680R-C76-9	CH580-C76-9	CH580R-C76-9	\$41.50
	12"	CH680-C76-12	CH680R-C76-12	CH580-C76-12	CH580R-C76-12	CALL
	18"	CH680-C76-18	CH680R-C76-18	CH580-C76-18	CH580R-C76-18	CALL
BUSHING TOOLS 1-PIECE 		CH680-BH-1PC	CH680R-BH-1PC	CH580-BH-1PC	CH580R-BH-1PC	63.50
CARBIDE INSERTED		CH680-BH-CARBIDE	CH680R-BH-CARBIDE	CH580-BH-CARBIDE	CH580R-BH-CARBIDE	\$159.80

Chipping Hammers  
and Parts Available



We Carry Chipping Hammers  
Check Our Web Sites:

- CrowderAirTools.com
- CrowderPneumatics.com
- CrowderHydraulicTools.com



**PAVING BREAKER TOOLS**



Shank Size / Len	MOIL POINT	NARROW CHISEL	PRICE	3" CHISEL	PRICE
7/8" X 3-1/4"	14" PB77-MP-14	PB77-NC-14	\$23.80	PB77-3C-14	\$33.00
	18" PB77-MP-18	PB77-NC-18	\$26.20	PB77-3C-18	\$36.20
7/8" X 4-1/4"	24" PB77-MP-24	PB77-NC-24	\$34.00	PB77-3C-24	\$36.20
	36" PB77-MP-36	PB77-NC-36	\$47.70	PB77-3C-36	\$73.60
1" X 4-1/4"	14" PB88-MP-14	PB88-NC-14	\$23.80	PB88-3C-14	\$33.00
	18" PB88-MP-18	PB88-NC-18	\$26.20	PB88-3C-18	\$36.20
	24" PB88-MP-24	PB88-NC-24	\$33.00	PB88-3C-24	\$45.90
	36" PB88-MP-36	PB88-NC-36	\$46.40	PB88-3C-36	\$70.60
	48" PB88-MP-48	PB88-NC-48	\$64.40	PB88-3C-48	\$101.50
	60" PB88-MP-60	PB88-NC-60	\$80.90	PB88-3C-60	\$133.50
1-1/8" X 6"	72" PB88-MP-72	PB88-NC-72	\$97.10	PB88-3C-72	\$161.30
	14" PB98-MP-14	PB98-NC-14	\$28.60	PB98-3C-14	\$37.50
	18" PB98-MP-18	PB98-NC-18	\$31.80	PB98-3C-18	\$40.20
	24" PB98-MP-24	PB98-NC-24	\$36.10	PB98-3C-24	\$49.90
	36" PB98-MP-36	PB98-NC-36	\$56.70	PB98-3C-36	\$78.80
	48" PB98-MP-48	PB98-NC-48	\$76.90	PB98-3C-48	\$112.20
1-1/4" X 6"	60" PB98-MP-60	PB98-NC-60	\$98.10	PB98-3C-60	\$145.50
	72" PB98-MP-72	PB98-NC-72	\$120.10	PB98-3C-72	\$181.70
	14" PB108-MP-14	PB108-NC-14	\$33.00	PB108-3C-14	\$41.10
	18" PB108-MP-18	PB108-NC-18	\$36.10	PB108-3C-18	\$45.50
	24" PB108-MP-24	PB108-NC-24	\$40.90	PB108-3C-24	\$52.70
	36" PB108-MP-36	PB108-NC-36	\$68.10	PB108-3C-36	\$89.40
	48" PB108-MP-48	PB108-NC-48	\$98.60	PB108-3C-48	\$130.40
	60" PB108-MP-60	PB108-NC-60	\$127.50	PB108-3C-60	\$170.20
	72" PB108-MP-72	PB108-NC-72	\$158.30	PB108-3C-72	\$211.80



Shank Size	ASPHALT CUTTER	PRICE	BRUSHING TOOL	PRICE	DIGGING CHISEL	PRICE
7/8" X 2-3/4"			PB77-BH	\$107.60		
7/8" X 3-1/4"	PB77-AC	\$84.40	PB78-BH	\$107.60	PB77-DC	\$93.90
7/8" X 4-1/4"	PB78-AC	\$84.40				
1" X 4-1/4"	PB88-AC	\$84.40	PB88-BH	\$94.60	PB88-DC	\$93.90
1-1/8" X 6"	PB98-AC	\$85.90	PB98-BH	\$100.40	PB98-DC	\$98.10
1-1/4" X 6"	PB109-AC	\$89.00	PB109-BH	\$102.90	PB109-DC	\$101.50



Shank Size	ASPHALT WEDGE	PRICE	FROST WEDGE	PRICE	CONCRETE BREAKER	PRICE
1" X 4-1/4"	PB88-AW	\$82.70	PB88-FW	\$102.5	PB88-CB	\$108.00
1-1/8" X 6"	PB98-AW	\$84.00	PB98-FW	\$102.5	PB98-CB	\$109.20
1-1/4" X 6"	PB109-AW	\$91.90	PB109-FW	\$102.5	PB109-CB	\$117.70



**PAVING BREAKER TOOLS**

Shank Size	Blade	CLAY SPADE	PRICE
7/8" X 3-1/4"	4-1/2"	PB77-CS-4.5	\$106.70
	5-1/2"	PB77-CS-5.5	\$106.70
7/8" X 4-1/4"	4-1/2"	PB78-CS-4.5	\$106.70
	5-1/2"	PB78-CS-5.5	\$106.70
1" X 4-1/4"	4-1/2"	PB88-CS-4.5	\$106.70
	5-1/2"	PB88-CS-5.5	\$106.70
1-1/8" X 6"	4-1/2"	PB98-CS-4.5	\$113.30
	5-1/2"	PB98-CS-5.5	\$114.00
1-1/4" X 6"	4-1/2"	PB109-CS-4.5	\$119.00
	5-1/2"	PB109-CS-5.5	\$119.00

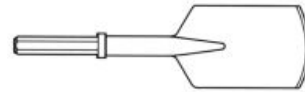

Shank Size	Rod Size	Socket Size	GROUND ROD DRIVER	PRICE
7/8" X 3-1/4"	5/8"	11/16"	PB77-GR-625	\$82.10
	3/4"	13/16"	PB77-GR-750	\$82.10
	5/8"	11/16"	PB88-GR-625	\$82.10
1" X 4-1/4"	3/4"	13/16"	PB88-GR-750	\$82.10
	7/8"	15/16"	PB88-GR-875	\$92.80
	1"	1-1/16"	PB88-GR-100	\$100.90
1-1/8" X 6"	5/8"	11/16"	PB98-GR-625	\$84.50
	3/4"	13/16"	PB98-GR-750	\$84.50
	7/8"	15/16"	PB98-GR-875	\$97.50
1-1/4" X 6"	1"	1-1/16"	PB98-GR-100	\$106.50
	5/8"	11/16"	PB108-GR-625	\$93.30
	3/4"	13/16"	PB108-GR-750	\$93.30
1-1/4" X 6"	7/8"	15/16"	PB108-GR-875	\$104.30
	1"	1-1/16"	PB108-GR-100	\$115.30



www.CrowderSupply.com • Toll Free: 888-883-5144

Shank Size	Hole Size	Unit	PLUG AND FEATHERS	PRICE
1-1/2"	1-1/2"	Shank	PB98-FW-SHK38	\$106.50
		Feathers	PB-FEATHERS-38	\$28.20
1-1/8" X 6"	2"	Shank	PB98-FW-SHK51	\$106.50
		Feathers	PB-FEATHERS-51	\$30.60
1-1/2"	1-1/2"	Shank	PB108-FW-SHK38	\$108.00
		Feathers	PB-FEATHERS-38	\$28.20
1-1/4" X 6"	2"	Shank	PB108-FW-SHK51	\$108.00
		Feathers	PB-FEATHERS-51	\$30.60

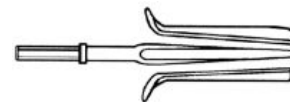

Shank Size	Blade	TARMAC CUTTER (10-1/2" under collar)	PRICE
1-1/8" X 6"	4-1/2"	PB98-TC	\$82.10
1-1/4" X 6"	4-1/2"	PB108-TC	\$83.30

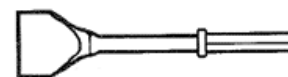

**PIPE DRIVING TOOLS**



Pad Size		TAMPING PADS	PRICE
6 "	Round	PB-TAMP-LT-6RD	\$117.70
	Square	PB-TAMP-LT-6SQ	\$117.70
7 "	Round	PB-TAMP-LT-7RD	\$117.70
8 "	Round	PB-TAMP-LT-8RD	\$140.60
	Square	PB-TAMP-LT-8S	\$140.60



Shank Size		PIPE DRIVERS	PRICE
7/8" x 4-1/4"	Shank only	SHK78-PIPE	\$105.00
1 x 4-1/4"	Shank only	SHK88-PIPE	\$105.00
1-1/8" X 6"	Shank only	SHK98-PIPE	\$110.00
1-1/4" X 6"	Shank only	SHK108-PIPE	\$110.00
CUP	Cup only	PD-PIPE-CUP	\$105.00



Size		SQUARE POST DRIVERS	PRICE
1-1/2 "	Small Taper	PD-ST-38SQ	\$92.50
	Large Taper	PD-LT-38SQ	\$92.50
1-3/4"	Small Taper	PD-ST-45SQ	\$92.50
	Large Taper	PD-LT-45SQ	\$92.50
2"	Small Taper	PD-ST-51SQ	\$92.50
	Large Taper	PD-LT-51SQ	\$92.50
2-1/4"	Large Taper	PD-LT-57SQ	\$100.0
2-1/2"	Large Taper	PD-LT-64SQ	\$110.0



Pad Size	Type	ROUND PIPE DRIVERS (for large taper shank)	PRICE
2"	Pin	PD-LT-51PIN	\$92.50
	Cup	PD-LT-51CUP	\$92.50
2-1/2"	Pin	PD-LT-64PIN	\$92.50
	Cup	PD-LT-64CUP	\$92.50
3 "	Pin	PD-LT-76PIN	\$100.0
	Cup	PD-LT-76CUP	\$105.00



Shank Size		DETACHABLE SHANK	PRICE
7/8" X 3-1/4"	Small Taper	PB77-SHK-ST	\$64.50
	Large Taper	PB77-SHK-LT	\$64.50
7/8" X 4-1/4"	Small Taper	PB78-SHK-ST	\$64.50
	Large Taper	PB78-SHK-LT	\$64.50
1" X 4-1/4"	Small Taper	PB88-SHK-ST	\$64.50
	Large Taper	PB88-SHK-LT	\$64.50
1-1/8" X 6"	Large Taper	PB98-SHK-LT	\$64.50
1-1/4" X 6"	Large Taper	PB108-SHK-LT	\$64.50

**Other Driver Tools  
Built to Your  
Specifications!**

Call us at 888-883-5144

**We Carry Post Drivers!  
Check Our Web Sites:**

- AirPostDrivers.com
- CrowderHydraulicTools.com

## Betonamit Expansive Cracking Agent



- ★ Excellent / not ecologically harmful
- ☆ Good
- ▼ Fair
- Unsatisfactory / ecologically harmful

EFFECT METHOD	Breaking Power	Situation on site				Safety	Safety Pre- cautions	Economy
		Noise	Dust/ Gas	Vibration	Rockfall			
Hydraulic Wedge	—	★	★	★	★	★	★	—
Rock Breaker	▼	▼	☆	☆	★	☆	★	▼
Jack Hammer	☆	▼	—	▼	▼	▼	—	▼
Dynamite	★	—	—	—	—	—	—	★
<b>BETONAMIT "R"</b>	☆	★	★	★	★	★	★	☆



Comparison chart

**BETONAMIT**, a highly expansive cracking agent, is supplied in powder form, sealed in handy 5kg plastic packs. It must be mixed with a specific quantity of clean cold water and poured into holes pre-drilled in the material to be cracked. After a few hours reaction time **BETONAMIT** exerts a huge expansive pressure, which quickly increases to such a degree that any hard rock, standard or reinforced concrete can be broken. **BETONAMIT** can be used both indoors and outdoors, in dry or humid conditions, even underwater.

This information is provided as a service and should not be relied upon. Always make sure you read and follow all instructions provided with product.

Visit our web site, CrowderSupply.com for PDF spec sheets.



www.CrowderSupply.com • Toll Free: 888-883-5144

## SCALING BARS



	ALUMINUM (1" SCH80)	BLACK PIPE (3/4" SCH40)	7/8" HEX SOLID	1" HEX SOLID
5'	SCB-AL-60	SCB-BP-60	SCB-22H-60	SCB-25H-60
6'	SCB-AL-72	SCB-BP-72	SCB-22H-72	SCB-25H-72
7'	SCB-AL-84	SCB-BP-84	SCB-22H-84	SCB-25H-84
8'	SCB-AL-96	SCB-BP-96	SCB-22H-96	SCB-25H-96
10'	SCB-AL-120	SCB-BP-120	SCB-22H-120	SCB-25H-120
12'	SCB-AL-144	SCB-BP-144	SCB-22H-144	SCB-25H-144
14'	SCB-AL-168	SCB-BP-168		
16'	SCB-AL-192	SCB-BP-192		
	SCB8073 - 1 1/8"Ø X .940 SHANK OFFSET CHISEL			
	SCB8071 - 7/8" HEX X .800 SHANK OFFSET CHISEL			

Other Scaling Chisels Built to Your Specifications





**Carbide Tipped Whirly Bit**



Drill	Bit	SHANK SIZE 7/8" X 3/4"	SHANK SIZE 7/8" X 4/4	PRICE
6"	5/8"	WB77-625-6	WB78-625-6	\$109.90
9"	5/8"	WB77-625-9	WB78-625-9	\$114.70
14"	5/8"	WB77-625-14	WB78-625-14	\$127.90
20"	5/8"	WB77-625-20	WB78-625-20	\$137.60
6"	3/4"	WB77-750-6	WB78-750-6	\$90.70
9"	3/4"	WB77-750-9	WB78-750-9	\$96.70
14"	3/4"	WB77-750-14	WB78-750-14	\$108.60
20"	3/4"	WB77-750-20	WB78-750-20	\$109.90
26"	3/4"	WB77-750-26	WB78-750-26	\$111.20
6"	7/8"	WB77-875-6	WB78-875-6	\$93.30
9"	7/8"	WB77-875-9	WB78-875-9	\$94.40
14"	7/8"	WB77-875-14	WB78-875-14	\$105.20
20"	7/8"	WB77-875-20	WB78-875-20	\$109.90
26"	7/8"	WB77-875-26	WB78-875-26	\$112.50
6"	1"	WB77-100-6	WB78-100-6	\$100.5
9"	1"	WB77-100-9	WB78-100-9	\$105.20
14"	1"	WB77-100-14	WB78-100-14	\$106.40
20"	1"	WB77-100-20	WB78-100-20	\$110.70
26"	1"	WB77-100-26	WB78-100-26	\$117.30
9"	1-1/8"	WB77-1125-9	WB78-1125-9	\$102.80
14"	1-1/8"	WB77-1125-14	WB78-1125-14	\$105.20
20"	1-1/8"	WB77-1125-20	WB78-1125-20	\$107.60
26"	1-1/8"	WB77-1125-26	WB78-1125-26	\$111.20
9"	1-1/4"	WB77-1250-9	WB78-1250-9	\$108.90
14"	1-1/4"	WB77-1250-12	WB78-1250-12	\$111.20
20"	1-1/4"	WB77-1250-20	WB78-1250-20	\$110.70
26"	1-1/4"	WB77-1250-26	WB78-1250-26	\$117.30
9"	1-3/8"	WB77-1375-9	WB78-1375-9	\$105.20
14"	1-3/8"	WB77-1375-14	WB78-1375-14	\$109.90
20"	1-3/8"	WB77-1375-20	WB78-1375-20	\$111.20
26"	1-3/8"	WB77-1375-26	WB78-1375-26	\$110.70
9"	1-1/2"	WB77-1500-9	WB78-1500-9	\$121.00
14"	1-1/2"	WB77-1500-14	WB78-1500-14	\$125.80
20"	1-1/2"	WB77-1500-20	WB78-1500-20	\$130.50
26"	1-1/2"	WB77-1500-26	WB78-1500-26	\$138.20

Drill	Bit	C-9 Whilibits	PRICE
8"	1/2"	WBCP9-500-8	\$88.80
10.5"	1/2"	WBCP9500-10.5	\$101.50
8"	5/8"	WBCP9-625-8	\$91.90
12"	5/8"	WBCP9-625-12	\$102.80
18"	5/8"	WBCP9-625-18	\$118.40
8"	3/4"	WBCP9-750-8	\$93.90
12"	3/4"	WBCP9-750-12	\$104.00
18"	3/4"	WBCP9-750-18	\$119.70
8"	7/8"	WBCP9-875-9	\$94.40
12"	7/8"	WBCP9-875-12	\$105.20
18"	7/8"	WBCP9-875-18	\$121.00
8"	1"	WBCP9-100-8	\$96.70
12"	1"	WBCP9-100-12	\$107.60
18"	1"	WBCP9-100-18	\$124.60
24"	1"	WBCP9-100-24	\$133.00
8"	1-1/8"	WBC9-1125-8	\$99.20
12"	1-1/8"	WBCP9-1125-12	\$118.50
18"	1-1/8"	WBCP9-1125-18	\$132.90
8"	1-1/4"	WBCP9-1250-8	\$107.60
12"	1-1/4"	WBCP9-1250-12	\$118.50
18"	1-1/4"	WBCP9-1250-18	\$132.90
8"	1-3/8"	WBCP9-1375-8	\$110.00
12"	1-3/8"	WBCP9-1375-12	\$121.00
18"	1-3/8"	WBCP9-1375-18	\$138.20
8"	1-1/2"	WBCP9-1500-8	\$118.50
12"	1-1/2"	WBCP9-1500-12	\$129.50
18"	1-1/2"	WBCP9-1500-18	\$137.90

www.CrowderSupply.com Toll Free: 888-883-5144

**Carbide Tipped Whirly Bit**

Drill	Bit	SHANK SIZE 1" X 4 1/4"		SHANK SIZE 3/4" X 3 1/4"		SHANK SIZE 3/4" X 4 1/4"	
			PRICE		PRICE		PRICE
6"	5/8"			WB57-625-5	Call	WB67-625-5	Call
6"	3/4"	WB88-750-6	Call	WB57-750-5	Call	WB67-750-5	Call
9"	3/4"	WB88-725-9	\$110.00				
12"	3/4"			WB-57-750-12	Call		
14"	3/4"	WB88-750-14	\$118.50				
18"	3/4"			WB57-750-18	Call		
20"	3/4"	WB88-750-20	\$119.70				
26"	3/4"	WB88-750-26	\$119.70	WB57-750-24	Call		
6"	7/8"	WB88-875-6	\$112.50	WB57-875-5	Call	WB67-875-5	Call
8"	7/8"						
9"	7/8"	WB88-875-9	\$110.70				
12"	7/8"						
14"	7/8"	WB88-875-14	\$114.90				
18"	7/8"						
20"	7/8"	WB88-875-20	\$117.30				
26"	7/8"	WB88-875-26	\$121.90				
6"	1"	WB88-100-6	Call	WB57-100-5	Call		
8"	1"						
9"	1"	WB88-100-9	\$123.40	WB57-100-9	Call		
12"	1"						
14"	1"	WB88-100-14	\$125.80				
18"	1"						
20"	1"	WB88-100-20	\$137.0				
24"	1"						
26"	1"	WB88-100-26	\$138.20				
www.CrowderSupply.com • Toll Free: 888-883-5144							
8"	1-1/8"			WB57-1125-7	Call	WB67-1125-7	Call
9"	1-1/8"	WB88-1125-9	\$127.90				
12"	1-1/8"						
14"	1-1/8"	WB88-1125-14	\$129.50				
18"	1-1/8"						
20"	1-1/8"	WB88-1125-20	\$133.00				
26"	1-1/8"	WB88-1125-26	\$139.10				
8"	1-1/4"						
9"	1-1/4"	WB88-1250-9	\$132.50				
12"	1-1/4"						
14"	1-1/4"	WB88-1250-12	\$131.80				
18"	1-1/4"						
20"	1-1/4"	WB88-1250-20	\$134.30				
26"	1-1/4"	WB88-1250-26	\$146.10				
8"	1-3/8"						
9"	1-3/8"	WB88-1375-9	\$127.00				
12"	1-3/8"						
14"	1-3/8"	WB88-1375-14	\$133.00				
18"	1-3/8"						
20"	1-3/8"	WB88-1375-20	\$139.10				
26"	1-3/8"	WB88-1375-26	\$146.10				
8"	1-1/2"						
9"	1-1/2"	WB88-1500-9	\$130.50				
12"	1-1/2"						
14"	1-1/2"	WB88-1500-14	\$138.60				
18"	1-1/2"						
20"	1-1/2"	WB88-1500-20	\$140.30				
26"	1-1/2"	WB88-1500-26	\$141.40				



Drill	Bit	U7 Whirlibits	
			PRICE
8"	1/2"	WBU7-500-8	\$127.40
10.5"	1/2"	WBU7-500-12	\$135.40
8"	5/8"	WBU7-625-8	\$127.40
12"	5/8"	WBU7-625-12	\$135.40
8"	3/4"	WBU7-750-8	\$127.40
12"	3/4"	WBU7-750-12	\$135.40
8"	7/8"	WBU7-875-8	\$102.10
12"	7/8"	WBU7-875-12	\$122.70
8"	1"	WBU7-100-8	\$114.10
12"	1"	WBU7-100-12	\$124.75
8"	1-1/8"	WBU7-1125-8	\$116.30
12"	1-1/8"	WBU7-1125-12	\$126.90
8"	1-1/4"	WBU7-1250-8	\$124.75
12"	1-1/4"	WBU7-1250-12	\$138.95

CROWDER  
SUPPLY

CROWDER  
PNEUMATICS

CROWDER  
HYDRAULIC  
TOOLS

CROWDER  
AIR  
TOOLS

AIR  
POST  
DRIVERS

Rhino

**Striking Bars & Shank Adapters**

SHANK	STRIKING BAR					EXTERNAL FLUSHING	
	3/4 X 4¼	7/8 X 3¼	7/8 X 4¼	1 X 4¼	1 X 6¼	7/8 X 4¼	1 X 4¼
7/8" ROPE	SB68R22	SB77R22	SB78R22	SB88R22		SB78R22EXT	
1" ROPE	SB68R25	SB77R25	SB78R25	SB88R25	SB89R25	SB78R25EXT	SB88R25EXT
1¼" ROPE	SB68R32	SB77R32	SB78R32	SB88R32	SB89R32		
1½" ROPE		SB77R38	SB78R38	SB88R38			
T38		SB77T38	SB78T38	SB88T38			

FLUSHING COLLAR SEALS	
SB-FC25-1	1" SEALS
SB-FC28-1	1 1/8" SEALS



FLUSHING COLLARS External Flush Striking Bars	
SB-FC25	1" FLUSHING COLLAR, 7/8" BAR
SB-FC28	1 1/8" FLUSHING COLLAR, 1" BAR



SHANK ADAPTERS			
ATLAS COPCO	GARDNER DENVER	KRUP	INGERSOLL RAND
BBC43,44,45,100	GD79, 93, 99,	HB81	VL120,VL140
BBC51,52,54,120	GD123	HB101	EVL130,F16
BBE57	PR123,133	HB103	VL671
COP115, 4050	HPR1		VL671TURBO
COP125,130,131,131EB	HPR-1H	<b>MONTABERT</b>	YD90
COP932/938	HPR2	HC40,80,90,100	YH65
COP1028HB,1028HD	PR55	HC120,150	YH65RP
COP1032HD,1032M	PR66	HC80R,120R,150R	YH70
COP1032LE		HC200R	YH70RP
COP1036,1038HB	<b>JOHN HENRY</b>		YH80
COP1038HD,1038HL	JHRD1	<b>TAMROCK</b>	YH80A
COP1238		HL300,300S	YH80RP
COP1432,1440,1838HD/ME	<b>JOY</b>	L400,L410,L500,L510	YH90
COP1432 female	VCR150	HLR438L,HLR438T	YH95
COP1550,1838ME/HE	VCR260,360	HLR438LS,438TS,HL538	YH95RPS
COP1840HE,COP1850	VCR261	L550S	YH100
	VCR280	HLR438TFS,HL538F	YH100VRP
<b>BOART</b>	VCR361	HL500-38,500 S-38	YH110V
HE125,150	RPD116	HL510-38,HL510 S-38	YH135
HD125,150		HL500-45,510-45	URD475,550
	<b>SECOMA</b>	HL500 F-38,510-F	MP317
<b>CANNON</b>	HYDRASTAR200	HL550 SUPER,560 SUPER	
CR460	HYDRASTAR300	HL510 S-45	
	HYDRASTAR350	L600, HL600-45,600 S-45	
<b>FURUKAWA</b>		HL600-52	
M120	<b>SIG</b>	LP600	
PD200	HBM100,150	TRP600	
HD300	HBM50,120	HL645,HL645S	
HD609	SIG 101	HL700-45	
HD612		HL700-52,700 S-52	
HD615	<b>LE ROI</b>	HL700-56, 700 S-56	
	155,455R,LHD155	HL850,850S	
		HL1000-52,1000 S-52	
	<b>TOYO</b>	HL1000-60,1000 S-80	
	PR220	HL1000 PE-52, 1500-52	
		HL1500-60,1500 S-80	
		HL1500 PE-52	

SHANK SEALS					
5/16	7/16	1/2	9/16	5/8	3/4
CS8MM	CS11MM	CS13MM	CS14MM	CS16MM	CS19MM

VISIT OUR WEB SITE CROWDERSUPPLY.COM FOR DETAILED SHANK ADAPTER PICTURES



**Threaded Steel & Bits**  
**1" ROPE - R25 - 100 ROPE**



	EXTENSION ROD		SHANKED ROD	
	7/8" HEX	1" HEX	7/8 X 4 1/4	1 X 4 1/4
18"	ER25-22H-12	ER25-25H-12	DS78R25-12	DS88R25-12
18"	ER25-22H-18	ER25-25H-18	DS78R25-18	DS88R25-18
2'	ER25-22H-24	ER25-25H-24	DS78R25-24	DS88R25-24
4'	ER25-22H-48	ER25-25H-48	DS78R25-48	DS88R25-48
6'	ER25-22H-72	ER25-25H-72	DS78R25-72	DS88R25-72
8'	ER25-22H-96	ER25-25H-96	DS78R25-96	DS88R25-96
10'	ER25-22H-120	ER25-25H-120	DS78R25-120	DS88R25-120
12'	ER25-22H-144	ER25-25H-144	DS78R25-144	DS88R25-144

COUPLING	
CPLR25	1" ROPE COUPLING

ADAPTERS	
CAR22-R25	7/8" ROPE - 1" ROPE
CAR25-R28	1" ROPE - 1 1/8" ROPE
CAR25-R32	1" ROPE - 1 1/4" ROPE
CAR25-R38	1" ROPE - 1 1/2" ROPE
CAR25-T38	1" ROPE - T 38"
CAR25-T45	1" ROPE - T45
BAR25-R38	1" ROPE (FM) - 1 1/2" ROPE (M)
BAR25-R32	1" ROPE (FM) - 1 1/4" ROPE (M)
BAR25-R28	1" ROPE (FM) - 1 1/8" ROPE (M)
BAR25-7811	1" ROPE (M) - 7/8" 11" TAPER
BAR25-T38	1" ROPE (FM) - T 38 (M)
BAR25-H	1" ROPE (FM) - H THD (M)

ROCK BITS			
	CROSS BIT	BUTTON BIT	REAMING BIT
1 3/8"	BCR2535	BBR2535	
1 1/2"	BCR2538	BBR2538	
1 5/8"	BCR2541	BBR2541	
1 3/4"	BCR2545	BBR2545	
1 7/8"	BCR2548	BBR2548	
2"	BCR2550	BBR2550	
2 1/4"	BCR2557	BBR2557	
2 1/2"	BCR2564	BBR2564	BRR2564
3"	BCR2576	BBR2576	BRR2576
3 1/2"			BRR2589
4"			BRR25102

**Button Types** - Round, Conical, Ballistic, Parabolic.

**Face Design** - Modified Chisel, Crown, Flat Face, Dome, Drop Center.

HOLE SAVER	
HSBR25	BELL HOLE SAVER 1" ROPE
HSSR25	SPEAR HOLE SAVER 1" ROPE

**FLUSHING COLLARS  
FOR EXTERNAL FLUSH  
STRIKING BARS**



STRIKING BAR					EXTERNAL FLUSH	
3/4 X 4 1/4	7/8 X 3 1/4	7/8 X 4 1/4	1 X 4 1/4	1 X 6 1/4	7/8 X 4 1/4	1 X 4 1/4
SB68R25	SB77R25	SB78R25	SB88R25	SB89R25	SB78R25EXT	SB88R25EXT

SB-FC25	1" FLUSHING COLLAR, 7/8 BAR
SB-FC28	1 1/8" FLUSHING COLLAR, 1" BAR



**Threaded Steel & Bits**  
**1 1/4" ROPE - R32 - 125 ROPE**



	EXTENSION ROD				SHANKED ROD	
	1 1/4" ROUND Single Thread	1 1/4" ROUND Double Thread	1" HEX	1 1/4" ROUND Male - Female	7/8 X 4 1/4	1 X 4 1/4
18"					DS78R32-18	DS88R32-18
2'	ER32-32R-24				DS78R32-24	DS88R32-24
30"					DS78R32-30	DS88R32-30
3'					DS78R32-36	DS88R32-36
4'	ER32-32R-48		ER32-25H-48	ER32-32R-51MF	DS78R32-48	DS88R32-48
5'				ER32-32R-63MF		
6'	ER32-32R-72		ER32-25H-72	ER32-32R-75MF	DS78R32-72	DS88R32-72
8'	ER32-32R-96		ER32-25H-96	ER32-32R-99MF	DS78R32-96	DS88R32-96
10'	ER32-32R-120	ER32-32R-120	ER32-25H-120	ER32-32R-123MF		DS88R32-120
12'	ER32-32R-144	ER32-32R-144		ER32-32R-147MF		DS88R32-144
14'	ER32-32R-168	ER32-32R-168				

**ROCK BITS**

	CROSS BIT	www.CrowderSupply.com • Toll Free: 888-883-5144	RETRAC BITS	REAMING BITS
1 3/8"	BCR3235	BBR3235		
1 5/8"	BCR3241	BBR3241		
1 3/4"	BCR3245	BBR3245		
1 7/8"	BCR3248	BBR3248		
2"	BCR3250	BBR3250		
2 1/4"	BCR3257	BBR3257		
2 1/2"	BCR3264	BBR3264		
3"	BCR3276	BBR3276		BRR3276
3 1/2"	BCR3289	BBR3289		BRR3289
4"	BCR32102	BBR32102		BRR32102
4 1/2"	BCR32115	BBR32115		BRR32115
5"	BCR32127	BBR32127		BRR32127

**Button Types** - Round, Conical, Ballistic, Parabolic.  
**Face Design** - Modified Chisel, Crown, Flat Face, Dome, Drop Center.

STRIKING BAR			
7/8 X 3 1/4	7/8 X 4 1/4	1 X 4 1/4	1 X 6 1/4
SB77R32	SB78R32	SB88R32	SB89R32

COUPLING	
CPLR32	1 1/4" ROPE COUPLING

HOLE SAVER	
H5BR32	BELL HOLE SAVER 1 1/4" ROPE
H5SR32	SPEAR HOLE SAVER 1 1/4" ROPE

ADAPTERS	
BAR32-R28	1 1/4" R (FM) - 1 1/8" R (M)
BAR32-R25	1 1/4" ROPE (FM) - 1" ROPE (M)
BAR32-R38	1 1/4" R (FM) - 1 1/2" R (M)
BAR32-T38	1 1/4" ROPE (FM) - T 38 (M)
BAR38-R32	1 1/2" R (FM) - 1 1/4" R (M)
CAR25-R32	1" ROPE - 1 1/4" ROPE
CAR28-R32	1 1/8" ROPE - 1 1/4" ROPE
CAR32-R38	1 1/4" ROPE - 1 1/2" ROPE
CAR32-T38	1 1/4" ROPE - T 38
CAR32-T45	1 1/4" ROPE - T45
CAR32-T51	1 1/4" ROPE - T51

**Threaded Steel & Bits**  
**1 1/2" ROPE - R38 - 150 ROPE**

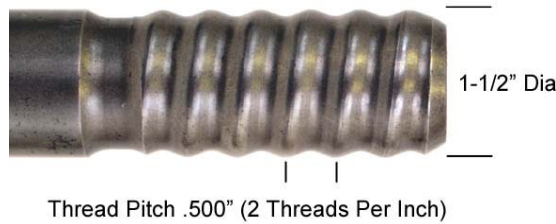

Thread Pitch .500" (2 Threads Per Inch)

**EXTENSION ROD**

	1 1/2" ROUND Single Thread	1 1/2" ROUND Double Thread	1 1/2" ROUND All Thread
4'	ER38-38R-48		ER38-ALL-48
5'			ER32-ALL-72
6'	ER38-38R-72		ER32-ALL-72
8'	ER38-38R-96		ER32-ALL-96
10'	ER38-38R-120	ER38-38R-120	ER32-ALL-120
12'	ER38-38R-144	ER38-38R-144	ER32-ALL-144
14'	ER38-38R-168	ER38-38R-168	ER32-ALL-168

**ROCK BITS**

		CROSS BIT	www.CrowderSupply.com • Toll Free: 888-883-5144	BUTTON BIT	RETRAC BIT	REAMING BITS	
2 1/4"		BCR3857		BBR3857			
2 1/2"		BCR3864		BBR3864		BCR3864RT	
3"		BCR3876		BBR3876		BCR3876RT	
3 1/2"		BCR3889		BBR3889		BCR3889RT	
4"		BCR38102		BBR38102		BCR38102RT	BRR38102
4 1/2"		BCR38115		BBR38115		BCR38115RT	BRR38115
5"		BCR38127		BBR38127		BCR38127RT	BRR38127
5 1/2"		BCR38140		BBR38140		BCR38140RT	BRR38140
6"	BCR38152	BBR38152	BCR38152RT	BRR38152			

**Button Types** - Round, Conical, Ballistic, Parabolic.  
**Face Design** - Modified Chisel, Crown, Flat Face, Dome, Drop Center.

**STRIKING BAR**

7/8 X 3 1/4	7/8 X 4 1/4	1 X 4 1/4	1 X 6 1/4
SB77R38	SB78R38	SB88R38	SB89R38

**COUPLING**

CPLR38	1 1/2" ROPE COUPLING
--------	----------------------

**HOLE SAVER**

HSBR38	BELL HOLE SAVER 1 1/2" ROPE
HSSR38	SPEAR HOLE SAVER 1 1/2" ROPE

**ADAPTERS**

CAR25-R38	1" ROPE - 1 1/2" ROPE
CAR32-R38	1 1/4" ROPE - 1 1/2" ROPE
CAR32-R38	1 1/4" ROPE - 1 1/2" ROPE
CAR32-R38	1 1/4" ROPE - 1 1/2" ROPE
CAR32-R38SQ	1 1/4" ROPE - 1 1/2" ROPE SQUARE
CAR38-T45	1 1/2" ROPE - T 45
BAR25-R38	1" ROPE (FM) - 1 1/2" ROPE (M)
BAR32-R38	1 1/4" R (FM) - 1 1/2" R (M)
BAR38-R32	1 1/2" R (FM) - 1 1/4" R (M)
BAR38-T38	1 1/2" ROPE (FM) - T 38 (M)
BAR38-T45	1 1/2" ROPE (FM) - T 45 (M)
BAR38-R51	1 1/2" ROPE (FM) - 2" ROPE (M)

CROWDER  
SUPPLY



CROWDER  
PNEUMATICS



CROWDER  
HYDRAULIC  
TOOLS



CROWDER  
AIR  
TOOLS



AIR  
POST  
DRIVERS





**Threaded Steel & Bits  
T38**

EXTENSION ROD				
	1 1/2" ROUND Single Thread	1 1/2" ROUND Double Thread	1 1/2" ROUND ALL THREAD	1 1/2" ROUND Male - Female
2'			ET38-ALL-24	
4'	ET38-38R-48		ET38-ALL-48	ET38-38R-52MF
5'			ET38-ALL-60	ET38-38R-64MF
6'	ET38-38R-72		ET38-ALL-72	ET38-38R-76MF
8'	ET38-38R-96		ET38-ALL-96	
10'	ET38-38R-120	ET38-38R-120T	ET38-ALL-120	ET38-38R-124MF
12'	ET38-38R-144	ET38-38R-144T	ET38-ALL-144	ET38-38R-148MF
14'	ET38-38R-168	ET38-38R-168T	ET38-ALL-168	
16'	ET38-38R-192	ET38-38R-192T		
18'	ET38-38R-216			

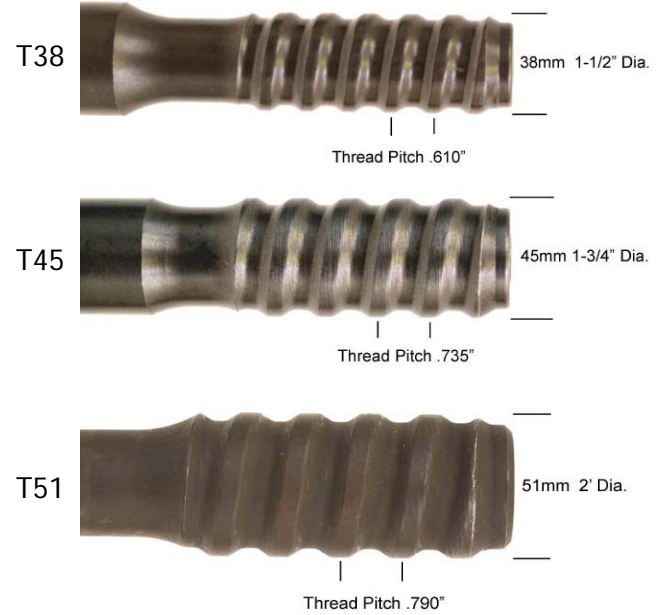

**ROCK BITS**

	CROSS BIT	BUTTON BIT	RETRAC BITS	REAMING BITS
2 1/4"		BCT3857	BBT3857	BBT3857RT
2 1/2"		BCT3864	BBT3864	BBT3864RT
2 3/4"		BCT3870	BBT3870	BBT3870RT
3"		BCT3876	BBT3876	BBT3876RT
3 1/2"		BCT3889	BBT3889	BBT3889RT
4"		BCT38102	BBT38102	BBT38102RT
4 1/2"		BCT38115	BBT38115	
5"		BCT38127	BBT38127	
5 1/2"			BBT38140	
6"		BBT38152		
8"		BBT38203		
				BRT3864
				BRT3870
				BRT3876
				BRT3889
				BRT38102
				BRT38115
				BRT38127
				BRT38140
				BRT38152

Button Types - Round, Conical, Ballistic, Parabolic.  
Face Design - Modified Chisel, Crown, Flat Face, Dome, Drop Center.

STRIKING BAR			
7/8 X 3 1/4	7/8 X 4 1/4	1 X 4 1/4	1 X 6 1/4
SB77T38	SB78T38	SB88T38	SB89T38

COUPLING	
CPLT38	T38 COUPLING

HOLE SAVER	
HSBT38	BELL HOLE SAVER T38
HSST38	SPEAR HOLE SAVER T38

ADAPTERS	
BAR32-R28	1 1/4" R (FM) - 1 1/8" R (M)
BAR32-R25	1 1/4" ROPE (FM) - 1" ROPE (M)
BAR32-R38	1 1/4" R (FM) - 1 1/2" R (M)
BAR32-T38	1 1/4" ROPE (FM) - T 38 (M)
BAR38-R32	1 1/2" R (FM) - 1 1/4" R (M)
CAR25-R32	1" ROPE - 1 1/4" ROPE
CAR28-R32	1 1/8" ROPE - 1 1/4" ROPE
CAR32-R38	1 1/4" ROPE - 1 1/2" ROPE
CAR32-T38	1 1/4" ROPE - T 38
CAR32-T45	1 1/4" ROPE - T45
CAR32-T51	1 1/4" ROPE - T51

**COUPLING**

CPLT45	T45 COUPLING
--------	--------------

**Threaded Steel & Bits  
T45**

**ADAPTERS**

CAR25-T45	1" ROPE - T45
CAR32-T45	1 1/4" ROPE - T45
CAR38-T45	1 1/2" ROPE - T 45
CAT38-T45	T 38 - T 45
CAT45-T51	T 45 - T 51
BAR38-T45	1 1/2" ROPE (FM) - T 45 (M)
BAR38-T45	T 38 (FM) - T 45 (M)
BAT45-T51	T45 (FM) - T 51 (M)
BSR32-T45	125ROPE (FM) - T45 (M)
BST45-HL18	T 45 (FM) - HL HL 1800 (M)
BST45-HL20	T 45 (FM) - HL 2000 (M)
BST45-T51	T 45 (FM) - HL T51 (M)

**EXTENSION ROD**

	1 3/4" ROUND Single Thread	1 3/4" ROUND Double Thread	1 3/4" ROUND All Thread	1 1/2" HEX Single Thread	1 3/4" ROUND Male - Female
2'			ET38-ALL-24		
4'			ET38-ALL-48		
5'			ET38-ALL-60		
6'			ET38-ALL-72		ET45-45R-76MF
8'			ET38-ALL-96		ET45-45R-100MF
10'	ET45-45R-120	ET45-45R-120T	ET38-ALL-120	ET45-38H-120	ET45-45R-124MF
12'	ET45-45R-144	ET45-45R-144T	ET38-ALL-144	ET45-38H-144	ET45-45R-148MF
14'	ET45-45R-168	ET45-45R-168T	ET38-ALL-168	ET45-38H-168	
20'	ET45-45R-216	ET45-45R-216T			ET45-45R-220MF

**HOLE SAVER**

HSBT45	BELL HOLE SAVER T45
HSST45	SPEAR HOLE SAVER T45

**ROCK BITS**

	CROSS BIT	BUTTON BIT	RETRAC BITS	REAMING BITS				
3"		BCT4576		BBT4576		BBT4576RT		BRT4576
3 1/2"		BCT4589		BBT4589		BBT4589RT		BRT4589
4"		BCT45102		BBT45102		BBT45102RT		BRT45102
4 1/2"		BCT45115		BBT45115		BBT45115RT		BRT45115
5"		BCT45127		BBT45127		BBT45127RT		BRT45127
5 1/2"				BBT45140				BRT45140
6"				BBT45203				BRT45152
8"								

www.CrowderSupply.com • Toll Free: 888-883-5144

Button Types - Round, Conical, Ballistic, Parabolic. Face Design - Modified Chisel, Crown, Flat Face, Dome, Drop Center.

**EXTENSION ROD**

	1 3/4" ROUND Single Thread	1 3/4" ROUND Male - Female
6'		ET51-51R-76MF
10'	ET51-51R-120	
12'	ET51-51R-144	ET51-51R-148MF
14'	ET51-51R-168	ET51-51R-172MF
20,	ET51-51R-216	ET51-51R-220MF

**Threaded Steel & Bits  
T51**

**COUPLING**

CPLT51	T51 COUPLING
--------	--------------





**HOLE SAVER**

HSBT51	BELL HOLE SAVER T51
HSST51	SPEAR HOLE SAVER T51

**ADAPTERS**

CAR32-T51	1 1/4" ROPE - T51
CAT38-T51	T38 - T51
CAT45-T51	T 45 - T 51
BAT38-T51	T38 (FM) - T 51 (M)
BAT45-T51	T45 (FM) - T 51 (M)
BSR32-T51	125ROPE (FM) - T51 (M)
BST38-T51	T 38 (FM) - HL T 51 (M)
BST45-T51	T 45 (FM) - HL T51 (M)

**ROCK BITS**

	CROSS BIT	BUTTON BIT	RETRAC BITS	REAMING BITS				
3"		BCT5176		BBT5176		BBT5176RT		
3 1/2"		BCT5189		BBT5189		BBT5189RT		
4"		BCT51102		BBT51102		BBT51102RT		
4 1/2"		BCT51115		BBT51115		BBT51115RT		BRT51115
5"		BCT51127		BBT51127		BBT51127RT		BRT51127
5 1/2"				BBT51140		BBT51140RT		BRT51140
6"				BBT51152		BBT51152RT		BRT51152
8"				BBT51203				

Button Types - Round, Conical, Ballistic, Parabolic. Face Design - Modified Chisel, Crown, Flat Face, Dome, Drop Center.

CROWDER  
SUPPLY

CROWDER  
PNEUMATICS

CROWDER  
HYDRAULIC  
TOOLS  
Atlas Copco

CROWDER  
AIR  
TOOLS

AIR  
POST  
DRIVERS  
Rhino

**ADAPTERS**



**COUPLING ADAPTERS**

CAR22-R25	7/8" ROPE - 1" ROPE
CAR25-R28	1" ROPE - 1 1/8" ROPE
CAR25-R32	1" ROPE - 1 1/4" ROPE
CAR25-R38	1" ROPE - 1 1/2" ROPE
CAR25-T38	1 " ROPE - T 38"
CAR25-T45	1" ROPE - T45
CAR28-R32	1 1/8" ROPE - 1 1/4" ROPE
CAR32-R38	1 1/4" ROPE - 1 1/2" ROPE
CAR32-R38SQ	1 1/4" ROPE - 1 1/2" ROPE SQUARE
CAR32-T38	1 1/4" ROPE - T 38
CAR32-T45	1 1/4" ROPE - T45
CAR38-T38	1 1/2" ROPE - T 38
CAR32-T51	1 1/4" ROPE - T51
CAR38-T45	1 1/2" ROPE - T 45
CAT38-T45	T 38 - T 45
CAT38-T51	T 38 - T 51
CAT45-T51	T 45 - T 51

**BIT ADAPTERS**

BAH-D	H THD (FM) - D THD (M)
BAR22-R25	7/8" ROPE (FM) - 1" ROPE (M)
BAR25-R38	1" ROPE (FM) - 1 1/2" ROPE (M)
BAR25-R32	1" ROPE (FM) - 1 1/4" ROPE (M)
BAR25-R28	1" ROPE (FM) - 1 1/8" ROPE (M)
BAR25-7811	1" ROPE (M) - 7/8" 11° TAPER
BAR25-T38	1" ROPE (FM) - T 38 (M)
BAR25-H	1" ROPE (FM) - H THD (M)
BAR32-R28	1 1/4" R (FM) - 1 1/8" R (M)
BAR32-R25	1 1/4" ROPE (FM) - 1" ROPE (M)
BAR32-R38	1 1/4" R (FM) - 1 1/2" R (M)
BAR32-T38	1 1/4" ROPE (FM) - T 38 (M)
BAR38-R32	1 1/2" R (FM) - 1 1/4" R (M)
BAR38-T38	1 1/2" ROPE (FM) - T 38 (M)
BAR38-T45	1 1/2" ROPE (FM) - T 45 (M)
BAR38-R51	1 1/2" ROPE (FM) - 2" ROPE (M)
BAT38-T45	T 38 (FM) - 1 1/2" ROPE (M)
BAT38-R32	T 38 (FM) - 1 1/4" ROPE (M)
BAR38-T45	T 38 (FM) - T 45 (M)
BAT38-T51	T 38 (FM) - T 51 (M)
BAT38-R32	T 38 (FM) - T 51 (M)
BAT45-T51	T45 (FM) - T 51 (M)
BAT38M-R25M	T38 (M) - R25 (M)



www.CrowderSupply.com • Toll Free 888-883-5144



**Save Money**

Recover that expensive drill string

*Save that Hole!*

**PROBLEM SOLVED!**

We specialize in the hard to find.  
Don't see what you need? **We will find it!**  
Can't find it? **We will Build it!**

Call us at **888-883-5144**

**HOLE SAVER**

HSBR25	BELL HOLE SAVER 1" ROPE
HSBR32	BELL HOLE SAVER 1 1/4" ROPE
HSBT38	BELL HOLE SAVER T 38
HSBT45	BELL HOLE SAVER T 45
HSBT51	BELL HOLE SAVER T 51
HSSR25	SPEAR HOLE SAVER 1" ROPE
HSSR32	SPEAR HOLE SAVER 1 1/4" ROPE
HSST38	SPEAR HOLE SAVER T 38
HSST45	SPEAR HOLE SAVER T 45
HSST51	SPEAR HOLE SAVER T 51

**SLEEVE ADAPTERS**

BSR32-T45	125ROPE (FM) - T45 (M)
BSR32-T51	125ROPE (FM) - T51 (M)
BSR38-HL18	150 ROPE (FM) - HL 1800 (M)
BSR38-HL20	150 ROPE (FM) - HL 2000 (M)
BST38-R51	T 38 (FM) - 2" ROPE (M)
BST38-HL18	T 38 (FM) - HL 1800 (M)
BST38-HL20	T 38 (FM) - HL 2000 (M)
BST38-T51	T 38 (FM) - HL T 51 (M)
BST45-HL18	T 45 (FM) - HL HL 1800 (M)
BST45-HL20	T 45 (FM) - HL 2000 (M)
BST45-T51	T 45 (FM) - HL T51 (M)





## Custom Manufacturing at our Denver Plant

**Crowder Supply Co, Inc.** has built a machining cell at its Denver plant using the newest CNC machines and automation. This allows us to supply your custom needs on a timely basis. We can manufacture your precision accessories from top quality raw material and provide heat treatment.

In addition to supplying parts for the mining and construction industries, our capabilities allow us to manufacture parts for all industrial applications with an emphasis toward long production runs.

**Our high level of automation means:**

- High Product Quality
- High level of Quality Control
- Competitive Pricing
- Fast Turnaround Times

Call us at 888-883-5144  
to Discuss Your Needs

[www.CrowderSupply.com](http://www.CrowderSupply.com) • Toll Free: 888-883-5144



### CROWDER SUPPLY CO. INC.

*Email:* [bart@crowdersupply.com](mailto:bart@crowdersupply.com)  
*Phone:* **888-883-5144 (toll free)**  
303-433-5144  
*Fax:* 303-433-3928  
*Address:* 8495 Roslyn Street  
Commerce City, CO 80022

**CROWDER  
SUPPLY****CROWDER  
PNEUMATICS****CROWDER  
HYDRAULIC  
TOOLS****CROWDER  
AIR  
TOOLS****AIR  
POST  
DRIVERS**

**CROWDER SUPPLY CO. INC.**

Email: bart@crowdersupply.com  
 Phone: **888-883-5144 (toll free)**  
 303-433-5144  
 Fax: 303-433-3928  
 Address: 8495 Roslyn Street  
 Commerce City, CO 80022



FIN HOE MUCKING SCOOP	EXPANSION SHELLS	DOWN THE HOLE BITS	DRAG BITS ROOF BOLT BITS
			
HARD HATS MINERS LIGHTS	MINERS BELTS	BUTTON BIT GRINDING CUPS	BOLT CENTRALIZERS
			
SLUSHER PINS SLUSHER BLOCKS	BETONAMIT Cracking Agent	HOLE PLUGS	FEATHER & WEDGE
			
ALUMINUM CONDUIT COUPLINGS	DOWN HOLE SHOCK SUBS	TRI CONE BITS	WICKET PINS
			
ADJUSTABLE COLUMN TOPS	CENTRALIZER SUBS	CENTRALIZER	CUSTOM MACHINING
			
PIPE DRIVING POINTS	PULL CLAWS PULL COLLARS	WE CAN BUILD IT	THE BOSS
			

www.CrowderSupply.com • Toll Free: 888-883-5144