

Safety and operating instructions

Hydraulic post drivers

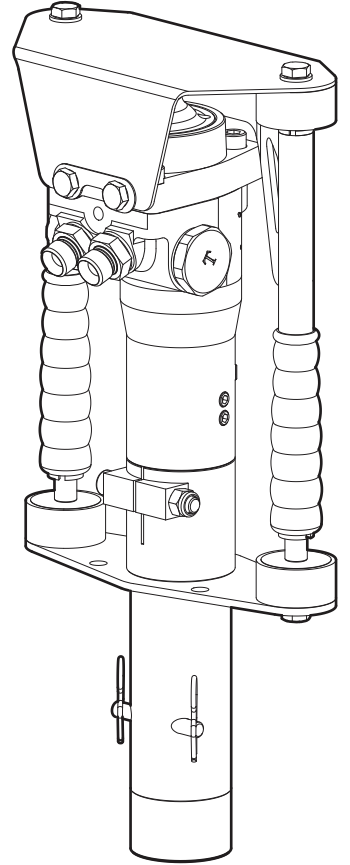

Contents

Introduction.....	5
About the Safety and operating instructions.....	5
Safety instructions.....	6
Safety signal words.....	6
Personal precautions and qualifications.....	6
Personal protective equipment.....	6
Drugs, alcohol or medication.....	6
Installation, precautions.....	6
Operation, precautions.....	7
Maintenance, precautions.....	10
Storage, precautions.....	10
Overview.....	11
Design and function.....	11
Main parts.....	11
Labels.....	11
Data plate.....	11
Noise level label.....	11
Accumulator.....	12
EHTMA.....	12
EHTMA category.....	12
Safety label.....	12
Installation.....	12
Hoses.....	12
Quick-release couplings.....	12
Hydraulic oil.....	12
Pressure adjustment.....	13
Adaptors.....	13
Operation.....	14
Start and stop.....	14
Connecting the post driver.....	14
Starting the post driver.....	14
Stopping the post driver.....	15
Disconnecting the post driver.....	15
When taking a break.....	15
Maintenance.....	15
Every day.....	15
Every month.....	16
Periodic maintenance.....	16
Storage.....	16
Disposal.....	16
Troubleshooting.....	17
Technical data.....	18
Machine data.....	18
Noise and vibration declaration statement.....	18
Noise and vibration data.....	18
EC Declaration of Conformity.....	19

EC Declaration of Conformity (EC Directive 2006/42/EC)..... 19

Introduction

Thank you for choosing a product from Atlas Copco. Since 1873, we have been committed to finding new and better ways of fulfilling our customers' needs. Through the years, we have developed innovative and ergonomic product designs that have helped customers improve and rationalize their daily work.

Atlas Copco has a strong global sales and service network, consisting of customer centers and distributors worldwide. Our experts are highly trained professionals with extensive product knowledge and application experience. In all corners of the world, we can offer product support and expertise to ensure that our customers can work at maximum efficiency at all times.

For more information please visit: www.atlascopco.com

Construction Tools EOOD

7000 Rousse

Bulgaria

About the Safety and operating instructions

The aim of the instructions is to provide you with knowledge of how to use the post driver in an efficient, safe way. The instructions also give you advice and tell you how to perform regular maintenance on the post driver.

Before using the post driver for the first time you must read these instructions carefully and understand all of them.

Safety instructions

To reduce the risk of serious injury or death to yourself or others, read and understand the Safety and operating instruction before installing, operating, repairing, maintaining, or changing accessories on the machine.

Post this Safety and operating instruction at work locations, provide copies to employees, and make sure that everyone reads the Safety and operating instruction before operating or servicing the machine.

In addition, the operator or the operator's employer must assess the specific risks that may be present as a result of each use of the machine.

Safety signal words

The safety signal words Danger, Warning and Caution have the following meanings:

DANGER	Indicates a hazardous situation which, if not avoided, will result in death or serious injury.
WARNING	Indicates a hazardous situation which, if not avoided, could result in death or serious injury.
CAUTION	Indicates a hazardous situation which, if not avoided, could result in minor or moderate injury.

Personal precautions and qualifications

Only qualified and trained persons may operate or maintain the machine. They must be physically able to handle the bulk, weight, and power of the tool. Always use your common sense and good judgement.

Personal protective equipment

Always use approved protective equipment. Operators and all other persons in the working area must wear protective equipment, including at a minimum:

- Protective helmet
- Hearing protection
- Impact resistant eye protection with side protection
- Respiratory protection when appropriate
- Protective gloves
- Proper protective boots
- Appropriate work overall or similar clothing (not loose-fitting) that covers your arms and legs.

Drugs, alcohol or medication

▲ **WARNING** Drugs, alcohol or medication

Drugs, alcohol or medication may impair your judgment and powers of concentration. Poor reactions and incorrect assessments can lead to severe accidents or death.

- ▶ Never use the machine when you are tired or under the influence of drugs, alcohol or medication.
- ▶ No person who is under the influence of drugs, alcohol or medication may operate the machine.

Installation, precautions

▲ **WARNING** Whipping hydraulic hose

Hydraulic hoses under pressure can whip uncontrollably if screws loosen or are loosened. A whipping hydraulic hose can cause severe injuries.

- ▶ Depressurise the hydraulic system before loosening the connection of a hydraulic hose.
- ▶ Tighten the nuts on the connections of the hydraulic hoses to the required torque.
- ▶ Check that the hydraulic hose and the connections are not damaged.

▲ **DANGER** Compressed gas, explosion hazard

The accumulator is pressurized even when the hydraulic system is shut off. To dismount the accumulator without first releasing the nitrogen gas can cause serious personal injury or death.

- ▶ Fill the high-pressure accumulator with nitrogen (N₂) only.
- ▶ Only authorised personnel are qualified to work with the accumulator.

▲ **WARNING** Hydraulic oil at high pressure

Thin jets of hydraulic oil under high pressure can penetrate the skin and cause permanent injury.

- ▶ Immediately consult a doctor if hydraulic oil has penetrated the skin.
- ▶ Never use your fingers to check for hydraulic fluid leaks.
- ▶ Keep your face away from any possible leaks.

▲ **WARNING** Hydraulic oil

Spilled hydraulic oil can cause burns, accidents due to slippery conditions and will also harm the environment.

- ▶ Take care of all spilled oil and handle it according to your safety and environmental regulations.
- ▶ Never dismount the hydraulic machine when the hydraulic oil is hot.

▲ WARNING Hot surfaces

Hydraulic oil temperatures higher than 60°C (140°F) is transmitted to the post driver body. The hot surfaces can burn if you are unprotected.

- ▶ Always use proper gloves and protective clothes, to avoid skin contact, when operating the machine.

▲ CAUTION Skin eczema

Hydraulic oil can cause eczema if it comes in contact with the skin.

- ▶ Avoid getting hydraulic oil on your hands.
- ▶ Always use protective gloves when working with hydraulic oil.
- ▶ Wash hands after contact with hydraulic oil.

Operation, precautions

▲ DANGER Explosion hazard

If an working tool comes into contact with explosives or explosive gases, an explosion could occur. When working on certain materials and when using certain materials in machine parts, sparks and ignition can occur. Explosions will lead to severe injuries or death.

- ▶ Never operate the machine in any explosive environment.
- ▶ Never use the machine near flammable materials, fumes or dust.
- ▶ Make sure that there are no undetected sources of gas or explosives.

▲ WARNING Operating pressure

If the maximum operating pressure for the hydraulic machine is exceeded, it can result in material damage and personal injury.

- ▶ Always run the hydraulic machine with the correct operating pressure. See "Technical data".

▲ WARNING Unexpected movements

The post is exposed to heavy strains when the machine is used. If the post breaks or gets stuck, there may be sudden and unexpected movement that can cause injuries. Furthermore, losing your balance or slipping may cause injury.

- ▶ When driving, make sure you are able to keep safely balanced. Keep arms and legs clear of the post. If a post breaks during operating, the post driver with a projecting broken shank will suddenly drop.
- ▶ Always inspect the equipment prior to use. Never use the equipment if you suspect that it is damaged.
- ▶ Make sure that the handles are clean and free of grease and oil.

- ▶ If you suspect that the post has struck a hidden object, stop the machine immediately. Make sure there is no danger before continuing with the work.
- ▶ Never lean against the post driver in order not to lose foothold, if the post should break by accident, or if the pile suddenly sinks.
- ▶ Never rest the post or the adaptor in a post driver on your foot or against your body.
- ▶ Never strike or abuse the equipment.
- ▶ Pay attention and look at what you are doing.

▲ WARNING Dust and fume hazard

Dusts and/or fumes generated or dispersed when using the machine may cause serious and permanent respiratory disease, illness, or other bodily injury (for example, silicosis or other irreversible lung disease that can be fatal, cancer, birth defects, and/or skin inflammation).

Some dusts and fumes created by drilling, breaking, hammering, sawing, grinding and other construction activities contain substances known to the State of California and other authorities to cause respiratory disease, cancer, birth defects, or other reproductive harm. Some examples of such substances are:

- Crystalline silica, cement, and other masonry products.
- Arsenic and chromium from chemically-treated rubber.
- Lead from lead-based paints.

Dust and fumes in the air can be invisible to the naked eye, so do not rely on eye sight to determine if there is dust or fumes in the air.

To reduce the risk of exposure to dust and fumes, do all of the following:

- ▶ Perform site-specific risk assessment. The risk assessment should include dust and fumes created by the use of the machine and the potential for disturbing existing dust.
- ▶ Use proper engineering controls to minimize the amount of dust and fumes in the air and to minimize build-up on equipment, surfaces, clothing, and body parts. Examples of controls include: exhaust ventilation and dust collection systems, water sprays, and wet drilling. Control dusts and fumes at the source where possible. Make sure that controls are properly installed, maintained and correctly used.
- ▶ Wear, maintain and correctly use respiratory protection as instructed by your employer and as required by occupational health and safety regulations. The respiratory protection must be effective for the type of substance at issue (and if applicable, approved by relevant governmental authority).

- ▶ Work in a well ventilated area.
- ▶ If the machine has an exhaust, direct the exhaust so as to reduce disturbance of dust in a dust filled environment.
- ▶ Operate and maintain the machine as recommended in the operating and safety instructions
- ▶ Select, maintain and replace consumables/ working tools/ other accessories as recommended in the operating and safety instructions. Incorrect selection or lack of maintenance of consumables/ inserted tools/ other accessories may cause an unnecessary increase in dust or fumes.
- ▶ Wear washable or disposable protective clothes at the worksite, and shower and change into clean clothes before leaving the worksite to reduce exposure of dust and fumes to yourself, other persons, cars, homes, and other areas.
- ▶ Avoid eating, drinking, and using tobacco products in areas where there is dust or fumes.
- ▶ Wash your hands and face thoroughly as soon as possible upon leaving the exposure area, and always before eating, drinking, using tobacco products, or making contact with other persons.
- ▶ Comply with all applicable laws and regulations, including occupational health and safety regulations.
- ▶ Participate in air monitoring, medical examination programs, and health and safety training programs provided by your employer or trade organizations and in accordance with occupational health and safety regulations and recommendations. Consult with physicians experienced with relevant occupational medicine.
- ▶ Work with your employer and trade organization to reduce dust and fume exposure at the worksite and to reduce the risks. Effective health and safety programs, policies and procedures for protecting workers and others against harmful exposure to dust and fumes should be established and implemented based on advice from health and safety experts. Consult with experts.
- ▶ Residues of hazardous substances on the machine can be a risk. Before undertaking any maintenance on the machine, clean it thoroughly.

▲ WARNING Projectiles

Failure of the work piece, of accessories, or even of the machine itself may generate high velocity projectiles. During operating, splinters or other particles from the working material may become projectiles and cause personal injury by striking the operator or other persons. To reduce these risk:

- ▶ Use approved personal protective equipment and safety helmet, including impact resistant eye protection with side protection.
- ▶ Make sure that no unauthorised persons trespass into the working zone.
- ▶ Keep the workplace free from foreign objects.
- ▶ Ensure that the work piece is securely fixed.

▲ WARNING Slipping, tripping and falling hazards

There is a risk of slipping or tripping or falling, for example tripping on the hoses or on other objects. Slipping or tripping or falling can cause injury. To reduce this risk:

- ▶ Always make sure that no hose or other object is in your way or in any other person's way.
- ▶ Always make sure you are in a stable position with your feet as far apart as your shoulders width and keeping a balanced body weight.

▲ WARNING Motion hazards

When using the machine to perform work-related activities, you may experience discomfort in the hands, arms, shoulders, neck, or other parts of the body.

- ▶ Adopt a comfortable posture while maintaining secure footing and avoiding awkward off-balanced postures.
- ▶ Changing posture during extended tasks may help avoid discomfort and fatigue.
- ▶ In case of persistent or recurring symptoms, consult a qualified health professional.

▲ CAUTION Hot machine

The insertion tool and the machine can become hot during use. Touching it can lead to burns.

- ▶ Never touch a hot insertion tool or machine.
- ▶ Wait until the insertion tool and the machine has cooled down before carrying out maintenance work.

▲ WARNING Vibration hazards

Normal and proper use of the machine exposes the operator to vibration. Regular and frequent exposure to vibration may cause, contribute to, or aggravate injury or disorders to the operator's fingers, hands, wrists, arms, shoulders and/or nerves and blood supply or other body parts, including debilitating and/or permanent injuries or disorders that may develop gradually over periods of weeks, months, or years. Such injuries or disorders may include damage to the blood circulatory system, damage to the nervous system, damage to joints, and possibly damage to other body structures.

If numbness, persistent recurring discomfort, burning sensation, stiffness, throbbing, tingling, pain, clumsiness, weakened grip, whitening of the skin, or other symptoms occur at any time, when operating the machine or when not operating the machine, stop operating the machine, tell your employer and seek medical attention. Continued use of the machine after the occurrence of any such symptom may increase the risk of symptoms becoming more severe and/or permanent.

Operate and maintain the machine as recommended in these instructions, to prevent an unnecessary increase in vibration.

The following may help to reduce exposure to vibration for the operator:

- ▶ Let the tool do the job. Use a minimum hand grip consistent with proper control and safe operation.
- ▶ If the machine has vibration absorbing handles, keep them in a central position, avoid pressing the handles into the end stops.
- ▶ When the percussion mechanism is activated, the only body contact with the machine you should have are your hands on the handle or handles. Avoid any other contact, for example supporting any part of the body against the machine or leaning onto the machine trying to increase the feed force. It is also important not to keep the start and stop device engaged while extracting the tool from the broken work surface.
- ▶ Immediately stop working if the machine suddenly starts to vibrate strongly. Before resuming the work, find and remove the cause of the increased vibrations.
- ▶ Never grab, hold or touch the inserted tool when using the machine.
- ▶ Participate in health surveillance or monitoring, medical exams and training programs offered by your employer and when required by law.
- ▶ When working in cold conditions wear warm clothing and keep hands warm and dry.

See the "Noise and vibration declaration statement" for the machine, including the declared vibration values. This information can be found at the end of these Safety and operating instructions.

▲ DANGER Electrical hazard

The machine is not electrically insulated. If the machine comes into contact with electricity, serious injuries or death may result.

- ▶ Never operate the machine near any electric wire or other source of electricity.
- ▶ Make sure that there are no concealed wires or other sources of electricity in the working area.

▲ WARNING Concealed object hazard

During operating, concealed wires and pipes constitute a danger that can result in serious injury.

- ▶ Check the composition of the material before operating.
- ▶ Watch out for concealed cables and pipes for example electricity, telephone, water, gas and sewage lines etc.
- ▶ If the inserted tool seems to have hit a concealed object, switch off the machine immediately.
- ▶ Make sure that there is no danger before continuing.

▲ WARNING Involuntary start

Involuntary start of the machine may cause injury.

- ▶ Keep your hands away from the start and stop device until you are ready to start the machine.
- ▶ Learn how the machine is switched off in the event of an emergency.
- ▶ Stop the machine immediately in all cases of power supply interruption.

▲ WARNING Noise hazard

High noise levels can cause permanent and disabling hearing loss and other problems such as tinnitus (ringing, buzzing, whistling, or humming in the ears). To reduce risks and prevent an unnecessary increase in noise levels:

- ▶ Risk assessment of these hazards and implementation of appropriate controls is essential.
- ▶ Operate and maintain the machine as recommended in these instructions.
- ▶ If the machine has a silencer, check that it is in place and in good working condition.
- ▶ Always use hearing protection.
- ▶ Use damping material to prevent work pieces from 'ringing'.

Maintenance, precautions

▲ WARNING Machine modification

Any machine modification may result in bodily injuries to yourself or others.

- ▶ Never modify the machine. Modified machines are not covered by warranty or product liability.
- ▶ Always use original parts and accessories approved by Atlas Copco.
- ▶ Change damaged parts immediately.
- ▶ Replace worn components in good time.

▲ WARNING Accessory hazards

Accidental engagement of accessories during maintenance or installation can cause serious injuries, when the power source is connected.

- ▶ Never inspect, clean, install, or remove accessories while the power source is connected.

Storage, precautions

▲ CAUTION Hot working tool

The tip of the working tool can become hot and sharp when used. Touching it can lead to burns and cuts.

- ▶ Never touch a hot or sharp working tool.
- ▶ Wait until the working tool has cooled down before carrying out maintenance work.
- ◆ Keep the machine and tools in a safe place, out of the reach of children and locked up.

Overview

To reduce the risk of serious injury or death to yourself or others, read the Safety instructions section found on the previous pages of this manual before operating the machine.

Design and function

LPD-LD is a hydraulically powered post driver designed for driving various types of sign posts, wood piles, and steel profiles with diameters up to 65 mm (2.56 in.), into the ground. No other use is permitted. Other diameters require the use of adaptors. To choose the correct adaptor, see the spare parts list. LPD-LD post driver can be equipped with a built-in control valve. LPD-LD is intended for use on an open centre hydraulic system.

Main parts

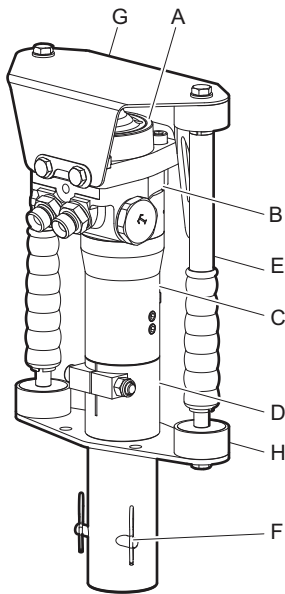

- A. Accumulator
- B. Valve housing
- C. Cylinder
- D. Nose part
- E. Handle with trigger
- F. Locking pin
- G. Cover
- H. Shock absorber

Labels

The machine is fitted with labels containing important information about personal safety and machine maintenance. The labels must be in such condition that they are easy to read. New labels can be ordered from the spare parts list.

Data plate

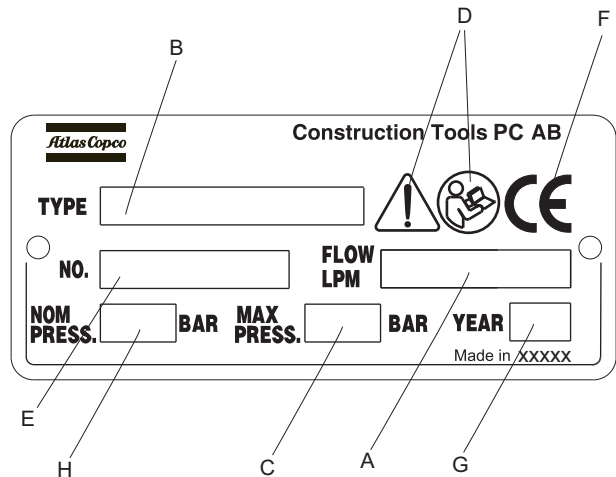

- A. Maximum permitted hydraulic oil flow
- B. Machine type
- C. Maximum relief valve setting
- D. The warning symbol together with the book symbol means that the user must read the safety and operating instructions before the machine is used for the first time.
- E. Serial number (is also stamped in the valve housing).
- F. The CE symbol means that the machine is EC-approved. See the EC declaration which is delivered with the machine for more information.
- G. Year of manufacture.
- H. Maximum nominal operating pressure

Noise level label

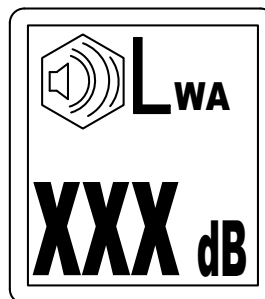

The label indicates the guaranteed noise level corresponding to EC-directive 2000/14/EC. See "Technical data" for accurate noise level.

Accumulator



The accumulator must only be charged with Nitrogen.

NOTICE Only certified personnel are allowed to work with the accumulator.

EHTMA

The European Hydraulic Tool Manufacturers Association (EHTMA) has categorised hydraulic power packs and tools in terms of flow rate and working pressure. See section "Technical data".

EHTMA category

The machine is clearly marked with EHTMA categories. It is important that any power source used is in a compatible category. If any doubt, consult an authorised supervisor.



Safety label



Installation

▲ WARNING Whipping hydraulic hose

Hydraulic hoses under pressure can whip uncontrollably if screws loosen or are loosened. A whipping hydraulic hose can cause severe injuries.

- ▶ Depressurise the hydraulic system before loosening the connection of a hydraulic hose.
- ▶ Tighten the nuts on the connections of the hydraulic hoses to the required torque.
- ▶ Check that the hydraulic hose and the connections are not damaged.

Hoses

For connection on the machine, the hydraulic hose must be approved for a working pressure of at least 172 bar (2,500 psi) and have a 12.7 mm (½ in.) inner diameter. To resist exterior wear and tear, we recommend using a 2-layer hydraulic hose. The machine connection marked P (pump) is the oil inlet, and the connection marked T (tank) is the oil outlet. Always connect both hoses and make sure that all hose connections are tight. Never carry the machine by the hose.

Quick-release couplings

The original hydraulic hoses are fitted with Flat-Face quick-release couplings that are strong and easy to clean. The quick-release couplings are fitted so that the male connection supplies oil and the female connection receives oil.

NOTICE Wipe all couplings clean before connecting. Ensure that couplings are clean and correctly engaged before operation. Failure to do so may result in damage to the quick couplings and cause overheating and cause foreign matter to enter the hydraulic system.

Hydraulic oil

In order to protect the environment, use of biologically degradable hydraulic oil is recommended. No other fluids must be used.

- ◆ Viscosity (preferred) 20-40 cSt.
- ◆ Viscosity (permitted) 15-100 cSt.
- ◆ Viscosity index minimum 100.

Standard mineral or synthetic oil can be used. Make sure to only use clean oil and filling equipment.

When the machine is used continuously, the oil temperature will stabilise at a level which is called the working temperature. This will, depending on the type of work and the cooling capacity of the hydraulic system, be between 20-40°C (68-104°F) above the ambient temperature. At working temperature, the oil viscosity must be within the preferred limits. The viscosity index indicates the connection between viscosity and temperature. A high viscosity is therefore preferred, because the oil can then be used within a wider temperature range. The machine must not be used, if oil viscosity fails to remain within the permitted area, or if the working temperature of the oil does not fall between 20°C (68°F) and 70°C (158°F).

Pressure adjustment

The maximum pressure of the power source is important. The pressure created in case of an incorrectly or unfitted return line coupling would cause overloading. Which could harm the machine and result in bodily injuries. The maximum pressure of the power source is 172 bar (limited by safety valve adjustment).

▲ WARNING Operating pressure

If the maximum operating pressure for the hydraulic machine is exceeded, it can result in material damage and personal injury.

- ▶ Always run the hydraulic machine with the correct operating pressure. See "Technical data".

Fitting the adaptor, 65 mm (2.56 in.)

1. Fit the conical anvil rod fully home into the driving head.
2. Insert anvil into front body and fix it with the fixing pin and lock with spring cotters.

Adaptors

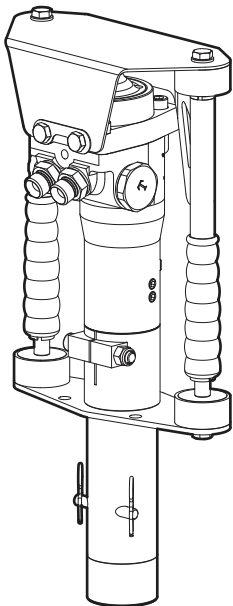

Always select a suitable adaptor for the post, pole, or star picket to be driven. **Use of the post driver without suitable adaptor may cause damage not covered by the technical warranty.** To choose the correct adaptor, see the spare parts list.

Fitting the adaptor, 16 mm (0.63 in.) or 25 mm (0.98 in.)

1. Fit the adaptor into the front body.
2. Fix it with the fixing pin and lock with spring cotters.

Optional adaptors

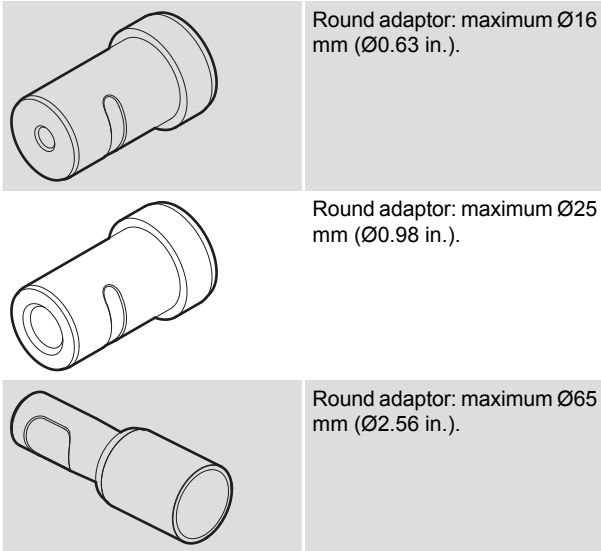

- ◆ **Oil supply:** If the oil supply of the power source exceeds the flow prescribed, the engine's rpm must be reduced, until correct oil flow is achieved. Test equipment can be used, see Spare parts list.
- ◆ **Oil flow divider:** If the oil flow cannot be adjusted by lowering the rpm, an oil flow divider must be installed. This will secure the post driver the correct oil flow and lead excess oil back to the tank (or to the operating valve block).
- ◆ **Pressure relief valve:** To protect the post driver against too high a pressure, the pressure relief valve of the powerpack must be set in accordance with the technical data. If that is not possible, connection can be made by installing a separate pressure relief valve. In case of doubt, contact your nearest authorised workshop.

Operation

▲ WARNING Involuntary start

Involuntary start of the machine may cause injury.

- ▶ Keep your hands away from the start and stop device until you are ready to start the machine.
- ▶ Learn how the machine is switched off in the event of an emergency.
- ▶ Stop the machine immediately in all cases of power supply interruption.

Start and stop

Connecting the post driver

Ensure that the hydraulic supply meets the requirements of the post driver, see "Technical data".

- ◆ Connect the hydraulic hoses. Make sure the hoses are clean before connecting them. The connectors are of the 'quick release' type.
- ◆ The power source must be fitted with a return line oil filter with a filter rating of 10-25µ.
- ◆ The back pressure (return line pressure) of the post driver must be as low as possible and may not exceed maximum. Back pressure, see "Technical data", measured at the post driver in order to avoid functional disturbances.
- ◆ Oil coolers must be able to stand a pressure of minimum 10 bar (145 psi) and must be provided with a by-pass valve opening at a pressure of 2 bar (29 psi) in case of pulsations in the return line.

The following is optional settings when connecting the post driver:

Starting the post driver

NOTICE In cold conditions, warm up the post driver by using it moderately for a few minutes before start working.

1. Always use a suitable adaptor for the post and for the post driver. Place the adaptor in the front head of the post driver. See section "Adaptors".
2. Remove the protective caps from the quick-release couplings.
3. Clean the quick-release couplings if needed and connect the tail-hoses to the extension hoses of the power source.
4. Insert the post into the post driver. It is possible to use an optional drive cap.

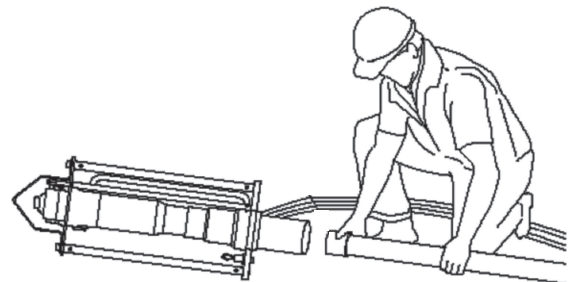

5. Lift the post and post driver to a vertical position. For long and heavy posts, two persons may be required.

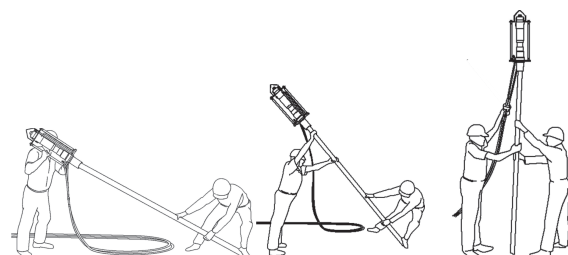

6. Activate the trigger by pressing the handles down. When the post driver is within reach, grasp the handles.
7. Avoid activating the post driver when it is removed from the post. This will otherwise lead to increased hydraulic oil temperatures and seal wear.
8. Do not invert the post driver without first isolating the hydraulic supply.
9. Do not continue to work if the hoses vibrate abnormally.
10. Investigate the contents of the material in which you are going to work. Look out for hidden cables and pipes, for example electricity, telephone, water, gas, or sewage lines.
11. Only use the machine for the jobs for which it is intended.

Stopping the post driver

1. Stop pressing the handles and lift the handle trigger.
2. Switch off the power supply.
3. Disconnect the hoses and fit the protective caps on the quick-release couplings.

Disconnecting the post driver

1. Isolate the hydraulic supply.
2. Disconnect the hoses by pulling up the locking rings and pulling up the couplings. Fit blanking caps to the hoses.

When taking a break

- ◆ During all breaks you must place the machine in such a way that there is no risk for it to be unintentionally started. Make sure to place the machine on the ground, so that it can not fall.
- ◆ In the event of a longer break or when leaving the workplace: Switch off the power supply and then bleed the machine by activating the start and stop device.

Maintenance

Regular maintenance is a basic requirement for the continued safe and efficient use of the machine. Follow the maintenance instructions carefully.

- ◆ Before starting maintenance on the machine, clean it in order to avoid exposure to hazardous substances. See “Dust and fume hazard”.
- ◆ Use only authorised parts. Any damage or malfunction caused by the use of unauthorised parts is not covered by warranty or product liability.
- ◆ When cleaning mechanical parts with solvent, comply with appropriate health and safety regulations and ensure there is satisfactory ventilation.
- ◆ For major service of the machine, contact the nearest authorised workshop.
- ◆ After each service, check that the machine's vibration level is normal. If not, contact the nearest authorised workshop.
- ◆ Tighten the sockets (A) to the required torque, do not over tighten. There are two sockets, one on each side on the machine. See the spare parts list for required torque.

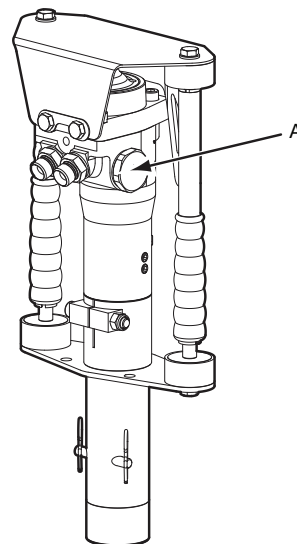

Every day

- ◆ Clean and inspect the machine and its functions each day before start working.
- ◆ Conduct a general inspection for leaks, damage, and wear.
- ◆ Change damaged parts immediately.
- ◆ Replace worn components in good time.
- ◆ Make sure that all the attached and related equipment, such as hoses and flow dividers are properly maintained.
- ◆ Clean the quick-release couplings before use.

Every month

- ◆ Check torque tightness of all fasteners.
- ◆ Check the bush in the nose casting for wear or damage. Replace if necessary.
- ◆ Check wear on the shank of the ramming tool.
- ◆ Spray suitable lubricant into the sliding bushings of the trigger-handle and anvil into the front body.

Periodic maintenance

After each operating period of approximately 600 impact hours or yearly the machine must be dismantled and all parts be cleaned and checked. This work must be performed by authorized staff, trained for this task.

Storage

- ◆ Disconnect the machine's hoses from the power source, see "Start and stop".
- ◆ Make sure that the machine is properly cleaned before storage.
- ◆ Always store the machine in a dry place.

Disposal

A used machine must be treated and scrapped in such a way that the greatest possible portion of the material can be recycled and any negative influence on the environment is kept as low as possible.

Before a used machine is scrapped it must be emptied and cleaned from all hydraulic oil. The remaining hydraulic oil must be deposited and any negative influence on the environment is to be kept as low as possible.

Troubleshooting

Problem	Cause	Solution
LPD fails to operate	No flow from supply	Check output with flow and pressure tester
	Hoses incorrectly fitted	Check that pressure feed is connected to P port on the LPD
	Main spool jammed or damaged	Remove and check, clean all associated parts
	Striker piston seized	Remove and check for damage and seizing marks
LPD lacks striking power	Insufficient available pressure	Check main relief valve and flow
	Low accumulator gas pressure (Normally associated with violent shaking of hoses)	Re-charge the accumulator, see service manual
LPD runs slow	Insufficient flow	Check that the flow rate is correct
	Cold oil	Warm up the oil supply, optimum temperature 30–70°C (86–158°F)
	High return line back pressure	Check return line back-pressure, pressure must not exceed 10 bar
	Incorrect oil	Use only Hydraulic Oil according to spec
	Quick release coupling defect	Locate and replace defect coupling
LPD runs hot	Inadequate cooling of hydraulic oil	Check oil supply has adequate cooling, temperature must not exceed 80°C (176°F)

Technical data

Machine data

	LPD-LD
Weight kg (lb)	17.5 (38.5)
Oil flow, l.p.m (gallon/minute)	20 (5,3)
Working pressure, bar (psi)	80-100 (1,160-1,450)
Maximum back pressure in return line, measured at post driver, bar (psi)	10 (145)
High-pressure accumulator charging pressure, nitrogen, bar (psi)	40 (580)
Maximum pressure relief valve setting, bar (psi)	172 (2,495)
Minimum pressure relief valve setting, bar (psi)	120 (1,740)
Impact rate at 20 l.p.m, blows/min	2,300
Hydraulic oil working temperature, °C (°F)	30-70 (86-158)
EHTMA category	C
Connections P and T, in.	Standard ½ BSP (alternatively ¾ JIC)
Required cooling capacity, in case of alternative power source, kW	Approximately 2

Noise and vibration declaration statement

Guaranteed sound power level **L_w** according to EN ISO 3744 in accordance with directive 2000/14/EC.

Sound pressure level **L_p** according to EN ISO 11203.

Vibration value **A** and uncertainty **B** determined according to EN ISO 28927-10. See table "Noise and vibration data" for the values of A, B, etc.

These declared values were obtained by laboratory type testing in accordance with the stated directive or standards and are suitable for comparison with the declared values of other tools tested in accordance with the same directive or standards. These declared values are not suitable for use in risk assessments and values measured in individual work places may be higher. The actual exposure values and risk of harm experienced by an individual user are unique and depend upon the way the user works, in what material the machine is used, as well as upon the exposure time and the physical condition of the user, and the condition of the machine.

We, Construction Tools EOOD, cannot be held liable for the consequences of using the declared values, instead of values reflecting the actual exposure, in an individual risk assessment in a work place situation over which we have no control.

This tool may cause hand-arm vibration syndrome if its use is not adequately managed. An EU guide to managing hand-arm vibration can be found at <http://www.humanvibration.com/humanvibration/EU/VIBGUIDE.html>

We recommend a programme of health surveillance to detect early symptoms which may relate to vibration exposure, so that management procedures can be modified to help prevent future impairment.

Noise and vibration data

Type	Noise			Vibration	
	Declared values			Declared values	
	Sound pressure	Sound power		Three axes values	
	EN ISO 11203	2000/14/EC		EN ISO 28927-10	
	L_p r=1m dB(A) rel 20µPa	L_w guaranteed dB(A) rel 1pW	Uncertainty value dB(A)	A m/s ² value	B m/s ² spreads
LPD-LD	102	116	2.1	17.5	2.5

EC Declaration of Conformity

EC Declaration of Conformity (EC Directive 2006/42/EC)

We, Construction Tools EOOD, hereby declare that the machines listed below conform to the provisions of EC Directive 2006/42/EC (Machinery Directive) and 2000/14/EC (Noise Directive), and the harmonised standards mentioned below.

Hydraulic post drivers	Guaranteed sound power level [dB(A)]	Measured sound power level [dB(A)]
LPD-LD	116	113

Following harmonised standards were applied:

- ◆ EN ISO 11148-4

Technical Documentation authorised representative:

Emil Alexandrov
Construction Tools EOOD
7000 Rousse
Bulgaria

General Manager:

Nick Evans

Manufacturer:

Construction Tools EOOD
7000 Rousse
Bulgaria

Place and date:

Rousse, 2012-06-01

Any unauthorized use or copying of the contents or any part thereof is prohibited.
This applies in particular to trademarks, model denominations, part numbers, and
drawings.

© 2015 Construction Tools EOOD | No. 3392 1337 01b | 2015-01-31

Atlas Copco

www.atlascopco.com